

Edition - 2

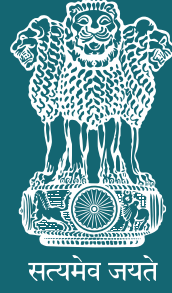

HANDBOOK FOR PRESIDING OFFICER 2023



भारत निर्वाचन आयोग
Election Commission of India
Nirvachan Sadan, Ashoka Road, New Delhi-110001

"No voter to be left behind"

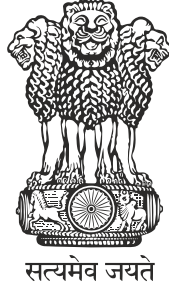

HANDBOOK FOR PRESIDING OFFICER 2023



भारत निर्वाचन आयोग

Election Commission of India

Nirvachan Sadan, Ashoka Road, New Delhi-110001

“No voter to be leftbehind”

“Making Elections Inclusive, Accessible, Participative, Safe and Inducement Free”

(This document is also available at ECI’s Website at <https://eci.gov.in>)

Document No : 324.6.EPS:HB:009:2023

TABLE OF CONTENTS

SECTION - I: CHAPTERS

SECTION - I: CHAPTERS		
CHAPTER - 01	PRELIMINARY	Page No.
1.1	INTRODUCTION	2
1.2	LEGAL PROVISIONS	2
1.3	POLLING PARTY	2
1.4	POLLING RELATED TRAININGS	2
1.5	APPLICATION FOR POSTAL BALLOT PAPER	3
1.6	POLLING MATERIALS	3
1.7	CHECKING OF EVM AND VVPAT	3
1.8	CHECKING OF POLLING MATERIALS	4
1.9	PHOTO ELECTORAL ROLLS	5
1.10	DUTIES OF POLLING OFFICERS IN SINGLE ELECTION	6
1.11	DUTIES OF POLLING OFFICERS IN SIMULTANIOUS ELECTION	8
1.12	PRESINDING OFFICER'S DUTY	9
1.13	CLOSING THE POLL	11
1.14	SECTOR OFFICER	12
1.15	VOTER ASSISTANCE BOOTH	12
CHAPTER - 02	SET UP OF POLLING STATIONS AND SECURITY ARRANGEMENTS	13 -25
2.1	ARRIVAL AT THE POLLING STATION	13
2.2	ABSENCE OF POLLING OFFICER	13
2.3	SET UP OF POLLING STATION FOR SINGLE ELECTION	13
2.4	SET UP OF POLLING STATIONS FOR SIMULTANEOUS ELECTION	14
2.5	VOTING PROCEDURE FOR SIMULTANEOUS ELECTIONS	15
2.6	OTHER PRECAUTIONS	16
2.7	DISPLAY OF NOTICE	16
2.8	PERSONS ENTITLED TO ENTER THE POLLING STATIONS	17
2.9	APPOINTMENT AND REVOCATION OF POLLING AGENTS	18
2.10	QUALIFICATION FOR APPOINTMENT AS POLLING AGENTS	18
2.11	PRODUCTION OF APPOINTMENT LETTERS BY POLLING AGENTS	18
2.12	ATTENDANCE OF POLLING AGENTS	19
2.13	PASSES FOR POLLING AGENTS	19
2.14	SEATING ARRANGEMENT OF POLLING AGENTS IN THE POLLING STATION	19
2.15	SMOKING PROHIBITED INSIDE POLLING STATION	20

2.16	FACILITIES TO PRESS REPRESENTATIVES AND PHOTOGRAPHERS AND VIDEOGRAPHY AT THE POLLING STATION	20
2.17	PHOTOGRAPHY/VIDEOGRAPHY	20
2.18	USE OF WEBCASTING AT POLLING STATION	21
2.19	FACILITIES TO OBSERVERS APPOINTED BY THE COMMISSION	22
2.20	MICRO OBSERVERS	22
2.21	WEARING OF BADGES ETC INSIDE THE POLLING STATION	23
2.22	SECURITY ARRANGEMENTS AT POLLING STATIONS	24
CHAPTER - 03	SETTING AND PREPARATION OF EVM AND VVPAT	26-41
3.1	INTRODUCTION TO EVM AND VVPAT	26
	3.1.1 ELECTRONIC VOTING MACHINE (EVM)	26
	3.1.2 VOTER VERIFIABLE PAPER AUDIT TRAIL (VVPAT)	29
3.2	SETTING UP OF EVM AND VVPAT BEFORE MOCK POLL AND CONDUCT OF MOCK POLL	30
	3.2.1 CONNECTING BU, CU AND VVPAT BEFORE MOCK POLL	30
3.3	CONDUCT OF MOCK POLL	32
	3.3.4 DEMONSTRATION OF 'CLEARING' OF EVM AND VVPAT BEFORE STARTING MOCK POLL	32
	3.3.5 PROCEDURE TO BE FOLLOWED TO CONDUCT MOCK POLL	33
3.4	SEALING OF CONTROL UNIT AND VVPAT AFTER COMPLETION OF MOCK POLL AND BEFORE STARTING ACTUAL POLL	35
	3.4.1 SEALING OF THE RESULT SECTION OF THE CONTROL UNIT WITH GREEN PAPER SEAL, SPECIAL TAG AND ADDRESS TAG	35
	3.4.2 EVM AND VVPAT READY FOR ACTUAL POLL	37
	3.4.3 MOCK POLL IN CASE OF REPLACEMENT OF EVM	37
	3.4.4 CRITICAL MISTAKES	38
	3.4.5 ACCOUNT OF PAPER SEALS	38
3.5	DON'T ON HANDLING ELECTRONIC VOTING MACHINE (EVM) AND VOTER VERIFIABLE PAPER AUDIT TRAIL (VVPAT)	38
3.6	POLL DAY INSTRUCTIONS ON EVM/VVPAT TO POLLING PARTIES	40
3.7	REPLACEMENT OF EVM/VVPAT DURING OR BEFORE ACTUAL POLL	41
CHAPTER - 04	POLLING PROCEDURE	42-54
4.1	ENFORCEMENT OF ELECTION LAW IN AND AROUND POLLING STATION	42
4.2	COMMENCEMENT OF THE POLL	43

4.3	VERIFICATION OF ELECTOR'S IDENTITY AND PROCEDURE IN CASE OF CHALLENGE	45
4.3.1	VERIFICATION OF ELECTOR'S IDENTITY	45
4.3.2	ABSENTEE VOTERS WHO HAVE BEEN ISSUED POSTAL BALLOT	47
4.3.3	LIST OF DEAD, ABSENT AND ALLEGED BOGUS VOTERS	47
4.3.4	CLERICAL AND PRINTING ERRORS IN THE ROLL TO BE OVERLOOKED	47
4.3.5	FACT OF ENROLMENT OF A VOTER NOT TO BE QUESTIONED	47
4.4	APPLICATION OF INDELIBLE INK AND OBTAINING SIGNATURE/ THUMB IMPRESSION OF ELECTOR BEFORE PERMITTING HIM/HER TO RECORD HIS/HER VOTE	47
4.4.1	INSPECTION OF VOTER'S LEFT INDEX FINGER AND APPLICATION OF INDELIBLE INK	47
4.4.2	APPLICATION OF INDELIBLE INK AT FRESH POLL (RE-POLL)/ COUNTERMANDED POLL	48
4.4.3	APPLICATION OF INDELIBLE INK WHEN ELECTOR HAS NO LEFT INDEX FINGER	48
4.4.4	RECORD OF ELECTORAL ROLL NUMBER OF ELECTOR IN REGISTER OF VOTERS	48
4.4.5	DEFINITION OF SIGNATURE OF ELECTOR	49
4.4.6	THUMB IMPRESSION OF ELECTOR	49
4.4.7	SIGNATURE/THUMB IMPRESSION ON THE 'REGISTER OF VOTERS' BY BLIND OR INFIRM OR LEPER ELECTORS	50
4.4.8	ISSUE OF VOTER'S SLIP TO ELECTOR	50
4.5	RECORDING OF VOTES AND VOTING PROCEDURE	50
4.5.1	RECORDING OF VOTE	50
4.5.2	PERMITTING ELECTOR TO RECORD VOTE	51
4.5.3	VOTING PROCEDURE	51
4.5.4	TALLYING OF NUMBER OF VOTES POLLED PERIODICALLY	52
4.5.5	PRESIDING OFFICER'S PRIVILEGE TO ENTER THE VOTING COMPARTMENT DURING POLL	52
4.6	HANDLING EVM & VVPAT DURING POLL	52
4.6.1	REPLACEMENT OF UNITS DURING ACTUAL POLL	52
4.6.2	REPORTS TO BE PREPARED FOR REPLACEMENT OF EVM/ VVPATs	54
4.6.3	COLLECTION OF PRESIDING OFFICER'S REPORT	54
CHAPTER - 05	SPECIAL CASES	55-60
5.1	REFUSAL TO OBEY THE VOTING PROCEDURE	55
5.2	VOTING BY BLIND AND PHYSICALLY INFIRM VOTERS	55
5.3	ELECTORS DECIDING NOT TO VOTE	56

5.4		VOTING BY PUBLIC SERVANTS ON ELECTION DUTY	56
	5.4.5	VOTING BY AN EDC ELECTOR	57
5.5		VOTING BY PROXY	57
5.6		TENDERED VOTE	58
	5.6.4	ACCOUNT OF TENDERED BALLOT PAPERS	58
	5.6.5	RECORD OF VOTERS TO WHOM TENDERED BALLOT PAPERS ISSUED	58
5.7		CHALLENGED VOTES	59
	5.7.2	CHALLENGING A VOTER'S IDENTITY	59
	5.7.3	CHALLENGE FEE	59
	5.7.4	SUMMARY INQUIRY	59
	5.7.5	RETURN OR FORFEITURE OF CHALLENGE FEE	59
5.8		PERSON WHOM YOU CONSIDER MUCH BELOW THE QUALIFYING AGE	59
5.9		TEST VOTE	60
CHAPTER - 06		ADJOURNMENT/STOPPAGE OF POLL DUE TO RIOT, BOOTH CAPTURING, ETC	61-62
6.1		ADJOURNMENT OF POLL DUE TO RIOT ETC	61
6.2		COMPLETION OF ADJOURNED POLL	61
6.3		STOPPAGE OF POLL FOR FAILURE OF EVM, BOOTH CAPTURING ETC	62
6.4		CLOSING OF VOTING MACHINE IN CASE OF BOOTH CAPTURING	62
CHAPTER - 07		CLOSE OF POLL	63-69
7.1		VOTING BY PERSONS PRESENT AT THE POLLING STATION AT THE CLOSING HOUR	63
7.2		CLOSING OF POLL	63
7.3		ACCOUNT OF VOTES RECORDED	64
	7.3.1	PREPARATION OF ACCOUNT OF VOTES RECORDED	64
	7.3.2	SUPPLY OF ATTESTED COPIES OF ACCOUNT OF VOTES RECORDED TO POLLING AGENTS	64
	7.3.3	DECLARATION TO BE MADE AT THE CLOSE OF THE POLL	65
7.4		SEALING OF THE EVM AND VVPAT AFTER CLOSE OF POLL	65
7.5		SEALING OF ELECTION PAPERS	66
	7.5.1	SEALING OF ELECTION PAPERS IN PACKETS	66
	7.5.2	PACKING OF STATUTORY, NON-STATUTORY COVERS AND ELECTION MATERIALS	65
	7.5.3	SEALING OF COVERS	68
7.6		PREPARATION OF THE DIARY AND DELIVERY OF VOTING MACHINES, VVPAT AND ELECTION PAPERS AT THE COLLECTION CENTRES	69

	7.6.1	PREPARATION OF THE DIARY	69
	7.6.2	TRANSMISSION OF EVM, VVPAT AND ELECTION PAPERS TO THE RETURNING OFFICER	69
CHAPTER - 08		CORRUPT PRACTICES AND ELECTORAL OFFENCES	70-71
8.1		PROHIBITION OF CANVASSING	70
8.2		PREVENTION OF VOTERS FROM VOTING	70
8.3		ILLEGAL HIRING OF VEHICLES FOR THE CONVEYANCE OF VOTERS	70
8.4		REMOVAL OF VOTING MACHINE AND/OR OTHER POLLING MATERIALS FROM POLLING STATION TO BE AN OFFENCE	70
8.5		REMOVAL OF DISORDERLY PERSONS	71
8.6		BREACH OF OFFICIAL DUTY BY ELECTION OFFICERS	71
8.7		PROHIBITION OF GOING ARMED TO OR NEAR A POLLING STATION	71
8.8		CASE OF IMPERSONATION	71
8.9		OFFENCE OF BOOTH CAPTURING	71
CHAPTER - 09		ACTIONABLE POINTS FOR PRESIDING OFFICERS/ POLLING OFFICERS AT A GLANCE	72-77
	9.A	COMMON MISTAKES	76
	9.B	DOs AND DON'Ts	76
	9.B.1	DOs AND DON'Ts ON USE OF VVPAT	76
	9.B.2	DOs AND DON'Ts OTHER THAN VVPAT	77
SECTION – II: ANNEXURES			
ANNEXURE – 1		EXTRACTS FROM THE REPRESENTATION OF THE PEOPLE ACT, 1951	79
ANNEXURE – 2		EXTRACTS FROM THE CONDUCT OF ELECTIONS RULES, 1961	86
ANNEXURE – 3		LIST OF POLLING MATERIALS FOR A POLLING STATION	96
ANNEXURE – 4		CERTIFICATE REGARDING THE ROLL TO BE USED AS MARKED COPY	99
ANNEXURE – 5		PRESIDING OFFICER'S REPORT	100
ANNEXURE – 6		DECLARATION BY THE PRESIDING OFFICER	106
ANNEXURE – 7		PRESIDING OFFICER'S DIARY	112
ANNEXURE – 8		FORM 17C	115
ANNEXURE – 9		OUTLINES OF FUNCTIONS TO BE PERFORMED BY PRESIDING OFFICERS AT VARIOUS STAGES	118
ANNEXURE – 10		CHECK MEMO FOR PRESIDING OFFICER	122
ANNEXURE – 11		POLLING AGENTS / RELIEVING AGENTS MOVEMENT SHEET	124
ANNEXURE – 12		SPECIMEN OF ENTRY PASS	125

ANNEXURE – 13	ACCOUNT OF ENTRY PASSES ISSUED TO POLLING AGENTS	126
ANNEXURE – 14	FORM OF DECLARATION BY ELECTOR WHOSE NAME IS IN ABSENTEE / SHIFTED / DEAD LIST (ASD LIST)	127
ANNEXURE – 15	FORM OF DECLARATION BY ELECTOR ABOUT AGE	128
ANNEXURE – 16	LIST RELATED TO UNDER-AGED ELECTORS	129
ANNEXURE – 17	DECLARATION UNDER RULE 49MA	130
ANNEXURE – 18	DECLARATION BY THE COMPANAION OF BLIND OR INFIRM ELECTOR	131
ANNEXURE – 19	RECEIPT BOOK	132
ANNEXURE – 20	LETTER OF COMPLAINT TO THE S.H.O. POLICE	133
ANNEXURE – 21	HANDLING OF CU-BU-VVPAT FAILURES/ERRORS DURING POLL PREPARATION OF POLLING OFFICIALS FOR FAULT HANDLING-SUGGESTIONS	134
ANNEXURE – 22	FORM M21- RECEIPT OF RETURN OF ELECTION RECORDS AND MATERIAL AFTER POLL	135
ANNEXURE – 23	VOTING COMPARTMENT – DIMENSIONS & CASCADING OF BALLOTING UNITS ON ONE SIDE - FACING THE WEB CAMERA	137

BRIEF OUTLINE OF DUTIES

During Training

- Full understanding of laws, provisions & latest instructions of Election Commission of India
- Proper understanding of EVM/VVPAT functioning
- Apply for Postal Ballot / EDC, if required.
- How to fill up various statutory and non-statutory forms

At Dispatch Centre

- Collection of materials & EVM/VVPAT machines as per list (Annexure-3)
- Special Focus on Items: Tendered Ballot Paper, Braille Ballot Sheet, Register of Voters (Form 17A), Marked Copy of Electoral Roll, Form 17C, Presiding Officer Diary, Tags, Seals, ASD, CSV lists, Specimen Signature of Candidates, Green Paper Seals, Pink Paper Seals, Black Envelope, Cello Tape
- Cast your postal ballot or collect EDC, if applied earlier.

Before Poll

- Setting up of polling station
- Conduct of Mock Poll on EVM & VVPAT
- Tallying result displayed on control unit with VVPAT mock poll slips.
- Clearing mock poll result from CU and remove mock poll slips from VVPAT drop box.
- Sealing of VVPAT mock poll paper slips after stamping on the backside in black envelope with pink paper seal

During Poll

- Briefing of Candidates/ Polling Agents on secrecy of votes
- Reading out Declaration of Poll loudly and obtaining signatures of Candidate/ Polling Agent
- Recording of entries in Form 17A, proper operation of EVM/VVPAT Machines
- Recording of certificate in Form 17A by PO1 and PrO before the first voter signs.
- Periodic tallying of total with Form 17A & communication of polling status to RO
- Recording of events in Presiding Officer Diary

Closure Time of Poll

- Give numbered slips to persons standing in queue at the time of closure of poll
- Press Close Button after all voters in queue cast their votes
- Remove VVPAT power pack.
- Sealing of EVM/VVPAT machines in proper carrying cases
- Sealing of Statutory, Non-Statutory Papers
- Taking Signature of all Polling Agents on Part I of Form 17C and to give authenticated copy of the same to all Polling Agents
- Move with security convoy to deposit all election materials at Receipt Centre

CONDUCT OF MOCK POLL

Setting up of Polling Station

- Seating Arrangement of Presiding Officer, Polling Officers, Polling Agents
- No violation of secrecy of voting and interior of Voting Compartment not visible to anyone.

Voting Compartment

- No direct light above the voting compartment
- No direct light from window
- Adequate light inside the booth to ensure visibility of BU.

Setting up EVM/ VVPAT

- BU, VVPAT to be inside Voting Compartment. VVPAT to be placed to the left side of 1st BU
- Cables not to be hidden but should not entangle with voter
- CU to be with 3rd Polling Officer
- Connectors to be connected with proper pin and color codes

Mock Poll

- Press Clear on CU, it will show 0 for all candidates
- Show VVPAT drop box to polling agents present in Voting Compartment that it is empty.
- At Least 50 numbers of votes must be cast with one vote for every unmasked button
- Press Close Button and then Result Button.
- Empty VVPAT paper slip compartment
- Compare CU Result and VVPAT paper slips
- Press Clear Button on CU
- Sign Mock Poll Certificate

Sealing of Machines

- Green Paper Seal in CU, take signatures of Presiding Officers and polling agents on paper seal
- Keep Account of Paper Seal
- Sealing of inner cover of CU with special Tag
- Sealing Outer Cover of Result Section with address Tag and Green Paper Seal
- Seal Paper slip drop box of VVPAT with address Tags

MOCK POLL FLOW CHART

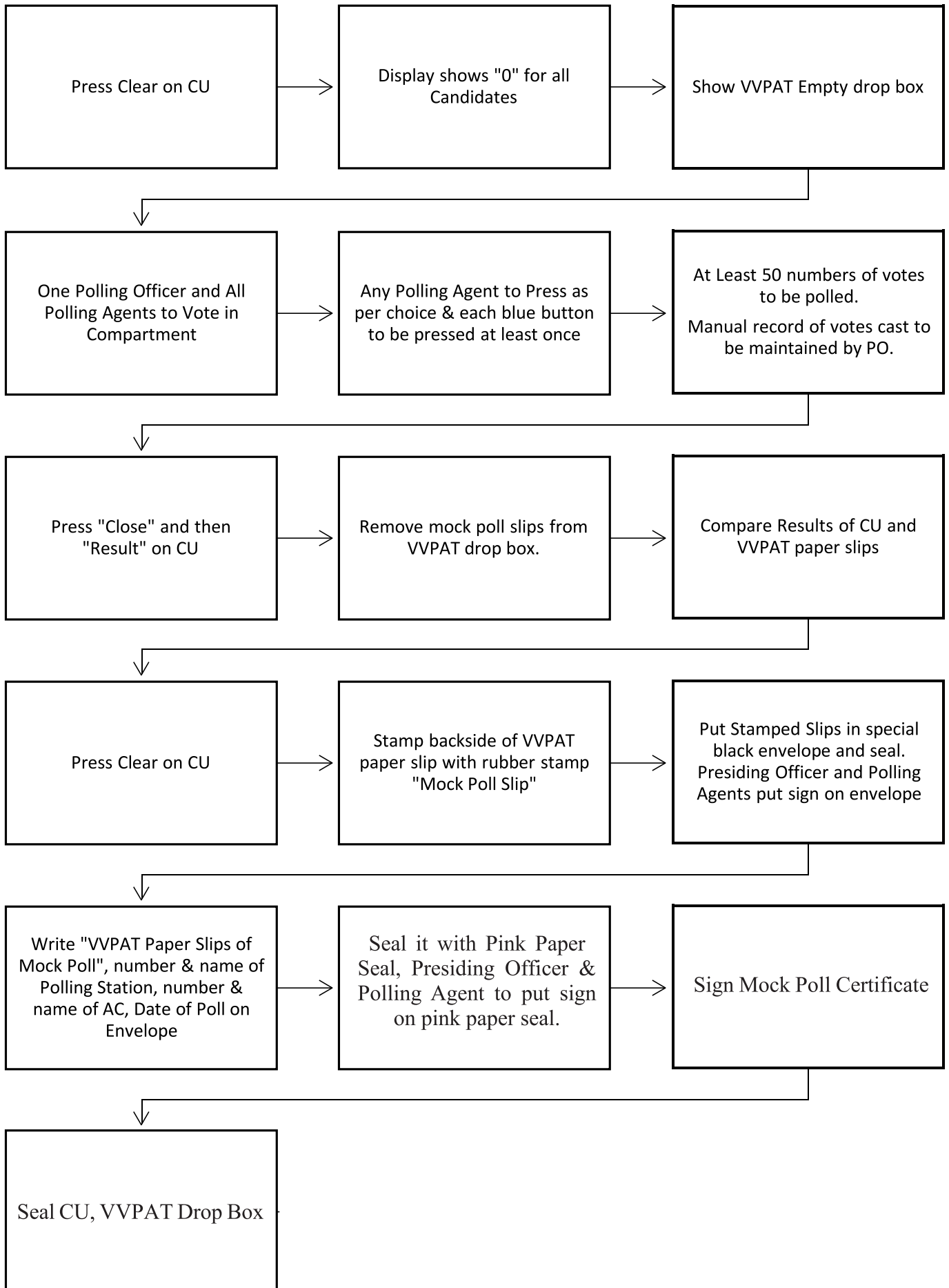

SPECIAL CIRCUMSTANCES & RESPONSE

Wrong Print on VVPAT Paper Slip

Voter may complain about wrong print on VVPAT paper slip against the button pressed on BU

- Rule 49MA provides for response in such cases.
- Get written declaration signed by elector.
- Presiding Officer to make second entry related to that elector in Form 17A.
- Permit elector to record test vote in presence of Presiding Officer & Polling Agents & Observe Paper slip
- If allegation found true, stop polling, and inform RO.
- If allegation is false, then mention in Form 17A, serial no. and name of candidate for whom such test vote has been recorded.
- Obtain Signature/Thumb Impression of elector on remarks.
- Make entries of such test vote in Part I of Form 17C

Defective EVM/VVPAT

CU, BU, VVPAT may become defective and require corrective step.

- If CU/BU & VVPAT does not work properly, replace whole set of CU, BU & VVPAT, conduct mock poll of 1 vote for each candidate including NOTA and follow all procedure of mock poll

Voter from ASD List

Absentee, Shifted & Dead Voter List is prepared by ERO/RO from field information

- Voter to produce EPIC or permitted photo document & Presiding Officer to verify personally.
- Thumb impression in addition to signature to be obtained in Register of Voters (Form 17A)
- Presiding Officer shall maintain a record and give a certificate at the end of poll about electors allowed from ASD list

Voter with unofficial identity slip

Contesting Candidate or Agent may give unofficial identity slip to any voter

- If unofficial identity slip contains name of contesting candidate and/or party and/or symbol, then instruct concerned polling agent to end such violation
- In case of illiterate voter, the 1st Polling Officer should read out serial number of elector and ask elector to tell him/her name to ascertain genuineness
- In case of impersonator, the person should be handed over to the police.
- In case of large number of women electors especially 'pardanashin' (burqa clad), a woman Polling Officer will carry out the above duties in a separate enclosure

Challenged Vote

Polling Agents may challenge identity of an elector by depositing a sum of Rs 2 with Presiding Officer

- Presiding Officer to hold a summary inquiry into the challenge
- If after summary enquiry, the challenge is not established, the elector should be allowed to vote
- If challenge is established, the elector shall be debarred from voting and shall be handed over to police with a written complaint

Declaration of Elector about his age

If Presiding Officer considers an elector much below the qualifying age

- Satisfy yourself about identity of an elector
- Obtain a declaration in proper format about his/her age as on 1st January / 1st April / 1st July / 1st October of the year of reference for electoral roll. Inform him/her about penal provision.
- Prepare a list of voters from whom you have obtained such declarations in Part I & Part II of Annexure on List related to Under Age electors.

Electors deciding not to vote

An Elector after his details are recorded in Form 17A and he has put his signature/thumb impression decides not to record his/her voter, he/she shall not be forced or compelled to record the vote

- In Register of Voters, put a remark “Refused to Vote” and Presiding Officer to sign below that remark.
- In Part I of Form 17C, in place under Rule 49-O in item 3 “Left without voting” or “Refused to vote” will be inserted.
- If Ballot button on CU is pressed, then next voter to be directed straight away to cast his vote.

Tendered Votes

It may happen that a person presents himself at the Polling Station and seeks to vote representing himself to be a particular elector and it is found that another person has already voted as such elector

- Satisfy about identity of that person to be elector concerned.
- If satisfied, allow such person to vote by means of a Tendered Ballot Paper and not by EVM.
- Keep account of Tendered Ballot Papers
- Record such electors in Form 17B.

HOW TO CAST YOUR VOTE

1

ENTER THE BOOTH



The Presiding Officer will enable the ballot Unit while you enter the polling compartment.



USING EVM & VVPAT

3

SEE THE LIGHT



The red light against the name/symbol of candidate chosen will glow

2

CAST YOUR VOTE



Press the Blue Button on the Ballot Unit against the name /symbol of candidate of your choice.

4

SEE THE PRINT



The Printer will print a ballot slip containing Serial Number, Name and Symbol of the chosen Candidate as shown.

See the print through the glass, as the printout will not be given to you

The slip will be visible for 7 seconds

NOTE!

If you do not see the ballot slip and hear the loud beep please contact the Presiding officer.



ELECTION COMMISSION OF INDIA

URL : <https://eci.nic.in>

SECTION - I

Chapters

CHAPTER – 01

PRELIMINARY

1.1. INTRODUCTION

- (i) The objective of this Handbook is to provide information and guidance to perform your duties as a Presiding Officer in the best manner possible. However, this Handbook is neither an exhaustive compendium in all aspects nor a substitute reference for the various provisions of election law related to the conduct of poll. You should, therefore, wherever necessary, refer to those legal provisions which are reproduced in **Annexures - 1 and Annexures - 2**.
- (ii) You have been appointed as a Presiding Officer under the provisions of Section 26 of the Representation of the People Act, 1951. Further, under the provisions of Section 28A, you, along with other officers designated for the conduct of any election, shall be deemed to be on deputation to the Election Commission for the period commencing on and from the date of the notification calling for such election and ending with the date of declaration of the results of such election. Accordingly, you shall during that period be subject to the control, superintendence, and direction of the Election Commission. As a Presiding Officer, you are the most important officer at the Polling Station. You enjoy full legal power to control the proceedings in the Polling Station under your charge. At the same time, you are fully responsible for all the activities taking place at the Polling Station. It is your primary duty and responsibility to ensure a free and fair poll at your Polling Station.

It is therefore, necessary that you are fully conversant with the law and procedure and the relevant instructions and directions of the Commission in relation to the conduct of elections. Presiding Officer (PrO) must perform all responsible duties in the Polling Station attached to him in cordial relation with other polling officials and Polling Agents in that Polling Station. You should go through the guidelines strictly without any deviation and act as per ECI instructions. You should attend all training classes, keep contact with Sector Officers/ Zonal Officers/ AROs/ ROs by having their contact numbers.

- (iii) Electronic Voting Machine (EVM) and Voter Verifiable Paper Audit Trail (VVPAT) are now used at each Polling Station. You, as the Presiding Officer at the Polling Station should acquaint yourself fully with the latest position on the rules and procedures prescribed for the conduct of poll by electronic voting machines and VVPAT. You should also thoroughly familiarize yourself with each of the steps to be taken in the conduct of poll at the Polling Station, and with the operation of EVM with VVPAT. You should understand the process of recording the vote using VVPAT. Hands-on-training must be done on use of EVMs with VVPATs. A slight mistake or lapse or wrong application of the law or rules or inadequate knowledge of various functions of the EVM with VVPAT may vitiate the poll at your Polling Station.

1.2. LEGAL PROVISIONS

The provisions of the law which have a bearing on your duties as a Presiding Officer is reproduced in **Annexures - 1 and Annexures - 2**.

1.3. POLLING PARTY

Typically, Polling team will consist of Presiding Officer and three Polling Officers. While appointing the Polling Party, your District Election Officer/Returning Officer will also authorize one of the Polling Officer to perform the duties of Presiding Officer in case you are not able to be on duty at the Polling Station due to some unavoidable reason. For the conduct of poll in simultaneous elections, the team will consist of Presiding Officer and five Polling Officers

1.4. POLLING RELATED TRAININGS

- (i) The District Election Officer/Returning Officer will arrange training classes for you and the Polling Officers. You and the Polling Officers should clear all doubts about the duties and responsibilities of the Presiding Officer and Polling Officers.
- (ii) One should not take training classes/rehearsals lightly. Even if you have worked as Presiding

Officer or Polling Officer in some earlier election, where EVM with VVPAT was used, you must attend all the training classes/rehearsals, as during the training classes/rehearsals you may come to know about VVPAT and some new facts/instructions/provisions of law. The election law and procedures are amended from time to time, and it is necessary that you keep yourself abreast about the latest provisions of law, rules, instructions etc. Further, it is always necessary to refresh your memory even if there is no change in the law and procedures. By the end of the training classes, you should be thorough in the operation of the EVM with VVPAT, fixing of green paper seal, special tag, all sealing procedure and about the various statutory and non-statutory forms used at Polling Station.

- Note:**
- Presiding Officer must attend test at the end of training module.
 - He/She should get acquainted, with different types of election materials including statutory, non-statutory forms, stationeries, covers, packets etc.
 - He/She should fill up Mock Poll Certificate.

1.5. APPLICATION FOR POSTAL BALLOT PAPER

- (I) You and your Polling Officers may be electors in the same constituency in which you are posted on duty or in some other constituency. The District Election Officer/Returning Officer will issue the order appointing you as Presiding Officer in duplicate and along with this order, the District Election Officer/Returning Officer will give you sufficient number of Form 12 and 12A to enable you and the Polling Officers to apply for Postal Ballot Papers and Election Duty Certificates. If any one of you is an elector in the same constituency in which you are appointed for election duty, you can apply for an Election Duty Certificate in Form 12A to the Returning Officer, in case of Parliamentary Elections. For an official, who is an elector from a constituency other than the one where one is posted on election duty, he will have to apply for a postal ballot paper in Form 12. Arrangements in this regard will be made in the training sessions. It may be noted that once a postal ballot is issued to you, you can vote only through postal ballot, even if you are not actually deployed for election duty for any reason.
- (ii) During training classes, a copy of each of the electoral rolls for all the Assembly Constituencies in the district will be made available by the District Election Officer for inspection at the centre(s), so that you can note down your particulars regarding electoral roll numbers, which you will have to furnish in your application for Postal Ballot Paper. You can also get your voter details from National Voter's Service Portal (NVSP) or through Voter Helpline App (VHA).

1.6. POLLING MATERIALS

On the previous day of poll or on the day of departure for the Polling Station, you will be supplied with all the election material, a list of which is set out in **Annexure - 3**. Before leaving for your Polling Station, make sure that you have received all the items.

1.7. CHECKING OF EVM AND VVPAT

- (I) Check that the Control Unit (CU), the Ballot Unit (BU) and VVPAT are the ones which are meant for use at your Polling Station. This shall be verified with reference to the address tags attached to the said units as the number and name of the Polling Station shall be indicated by the Returning Officer on each of those address tags.
- (ii) Check that the 'Candidate Set Section' of Control Unit is duly sealed and the address tag is firmly attached thereto. Also check that the Pink Paper Seal on the control unit is intact.
- (iii) Check that the battery installed in the Control Unit (CU) is fully operational. This may be checked by setting the Power Switch provided in the rear compartment to 'ON' position. **After checking, the power switch must be set to 'OFF' position.**
- (iv) Check that Polling party is instructed **NOT TO TEST VVPAT** at the time of dispersal and before mock poll at polling station under any circumstance, as VVPAT issued to them are already checked & tested.

- (v) Check that you have been supplied with the requisite number of Ballot Units (BUs) and the ballot papers are duly fixed under the Ballot Paper Screen in each of them. The number of Ballot Units to be supplied to you will depend upon the number of contesting candidates in your constituency.
- (vi) **Check the Thumbwheel switch setting in M3 EVM's Ballot Unit:**

The thumbwheel switch window is on the top right side of the Ballot Unit. Note that in M3 EVM, 24 Ballot Units can be connected to Control Unit. If the number of contesting candidates is between 3 and 16(including NOTA), only one Ballot Unit will be supplied and the thumb-wheel switch can be seen through the window at the top-right of the Ballot Unit set by the Returning Officer at position '01'. If the number of contesting candidates is between 16 and 32 including NOTA, you will be supplied with two Ballot Units. On the first Ballot Unit in thumbwheels will be set to position '01' and the ballot paper will contain the names of the candidates from Sl. Nos., 1 to 16 in the list of contesting candidates.

No. of Contesting Candidates (Including NOTA)	No. of Ballot Unit connected to CU	Position on Thumb wheel
03 - 16	1	01
17 - 32	2	02
33 - 48	3	03
....
369 - 384	24	24

The second Ballot Unit will display the second sheet of the ballot paper containing the names of contesting candidates from 17 onwards (and up to 32 including NOTA) and the Thumbwheels in that unit will be set to the position '02'. Likewise, if three Ballot Units are supplied then number of contesting candidates is between 33 and 48 including NOTA. In the third Ballot Unit, the ballot paper will contain the names of candidates

from Sl. Nos. 33 onwards (up to 48 including NOTA) and its thumbwheels will be set to the position '03'. There will be four Ballot Units, if the number of candidates exceeds 47 and is up to 64 (including NOTA). The fourth Ballot Unit will display on the ballot paper fixed therein the names of candidates from serial No. 49 onwards (up to 64 including NOTA) and its thumbwheels will show the position '04'. If there are five Ballot Units, the fifth Ballot Unit will display on the ballot paper fixed therein the names of candidates from serial No. 65 onwards (up to 80 including NOTA) and its thumbwheels will show the position '05'. In this way, when using 24 BUs, the twenty-fourth BU will display on the ballot paper fixed therein the names of candidates from serial No. 369 onwards (up to 384 including NOTA) and its thumbwheels will show the position '24'.

- (vii) If you find any discrepancy in the fixing of the thumbwheel switch, immediately bring it to the notice of Sector Magistrate/Returning Officer. But in any case, you or your Polling Officers should not fiddle with the thumbwheel switch.
- (viii) It must also be ensured that the ballot papers as fixed on the Ballot Units are properly aligned and that the name and symbol of each candidate is in line with his corresponding lamp and button and the thick lines dividing the panels of the candidates on the ballot paper are in line with the corresponding grooves on the Ballot Unit.
- (ix) Check that the candidates' blue buttons which have been unmasked and are visible on the Ballot Units are equal to the number of contesting candidates, and that the remaining buttons, if any, have been masked.
- (x) Check that each of the Ballot Unit is duly sealed and secured at two places, i.e. at right top and right bottom portions, with the seals of the Returning Officer, and that the address tags are firmly attached thereto.

1.8. CHECKING OF POLLING MATERIALS

- (i) Check that two big phials of 10 cc of indelible ink with brush have been provided in the kit and there is sufficient quantity of ink in each of the two phials supplied to you since ink has to be put on the left-hand index finger as a line from the top of the nail to the bottom of first joint of the finger
- (ii) Ensure that the stamp pads to be used for getting the thumb impression of the voter who cannot put his/her signature are not dry.

- (iii) Check that all the three copies (in the case of simultaneous poll five copies) of the relevant part of the electoral roll are complete and identical in every respect and, in particular, that the relevant part given to you pertains to the area for which the Polling Station has been set up and that it is complete in all respects.
- (iv) All the pages in each working copy of the roll have been serially numbered from No.1 onwards.
- (v) The printed serial numbers of the voters are not corrected with ink or otherwise and no new numbers are substituted for them.
- (vi) The marked copy of the electoral roll (copy of the electoral roll to be used for ‘marking’ the names of electors, who are allowed to vote) does not contain any remarks other than those used for issuing postal ballot papers (such as ‘PB’ ‘EDC’). The deletions appearing in the supplements, if any, to the roll would be reflected in the reprinted mother roll with the word “D E L E T E D” diagonally (in case of deletion made during revision period) or “DELETED” “DELETED” in cross, (in case of deletion made during continuous period after final publication), as the case may be; superimposed on the concerned elector detail box to indicate that the entry has been deleted.
- (vii) The electoral roll is duly signed by one of the AEROs and one more official.
- (viii) A certificate signed in ink by the RO/ARO is attached on the top of one copy of the roll to be used as marked copy. **(Annexure - 4)**
- (ix) Check that along with the marked copy of the electoral roll the list of absentees, shifted & Dead (ASD) voters, if any, has been given to you to facilitate identification of voters at the Polling Station.
- (x) Check that the tendered ballot papers supplied to you are for the same constituency in which the Polling Station assigned to you is situated and that they are not defective in any respect. You should also check that their serial numbers tally with the details supplied to you.
- (xi) If you find any voting machine or any polling material defective in any respect, you must immediately bring such defect to the notice of the officer in-charge of distribution of voting machines/polling materials or the Returning Officer for necessary remedial action.
- (xii) Also check that photocopies of specimen signatures of the contesting candidates and their Election Agents are also given to you. This will help you in verifying genuineness of the signatures of the candidates/their Election Agent in the appointment letter of polling agent(s) at the Polling Station.
- (xiii) In addition to the above-mentioned documents check for two copies of trouble shooting instructions on handling of CU-BU-VVPAT failures/errors **(Annexure – 20)** during poll preparation of polling officials for fault handling and polling materials provided for your booth should be as per list of polling materials given in **Annexure – 3**.

1.9. PHOTO ELECTORAL ROLLS

- (i) The latest Photo Electoral Rolls (PER) is available in respect of your constituency. The Photo Electoral Roll contains the photographs of the electors in addition to all the information. This simplifies the process of verification of elector’s identity at the Polling Station on the poll day.
- (ii) All the additions made during period of revision/continuous updation from last final publication date till the last date of making nominations (where elections are due), are put in chronological order giving continuous Sl. No. starting with next Sl. No. of last entry in final roll, with all deletions & modifications marked in last draft/final roll as per Commission’s existing instructions.
- (iii) All the entries which have been modified/corrected on the basis of Form-8, during the period of revision/continuous updation, will be reflected in the integrated roll itself replacing the existing entries, with the sign of # (in case of corrections were made during summary revision) or ## (in case of corrections were made during continuous updation period after final publication), as the case may be to indicate that the entry has been modified and replaced. An image of dummy marked copy of Electoral Roll is shown below:

Dummy Marked Copy of Electoral Roll

Sr. No. 18 RJ/12/094/909297 Name: AB Father Name: DELETED House No.: 7/10 Age: 42 Sex: M	Sr. No. 19 RJ/32/194/239276 Name: DF Husband Name: RT House No.: 3/11 Age: 21 Sex: F
Sr. No. 20 UCW1075683 Name: EW Father Name: JU House No.: 4/01 Age: 19 Sex: M	Sr. No. 21 UCW0389675 Name: TY Father Name: FH House No.: 305 Age: 83 Sex: M

- (iv) As per the directions of the Commission the EPIC is used for identification of electors at the Polling Stations. However, a separate order will be issued for the purpose of identification by means of any alternative documents as prescribed by the Commission for each election.
- (v) The Election Commission has directed that identification of overseas electors at the time of casting of votes at Polling Station shall be done only based on original Indian passport containing the elector’s residential address produced by them.

In so far as the production of EPIC for verification of the elector’s identity is concerned, it may be clarified that if an elector produces an Elector Photo Identity Card, which has been issued by the Electoral Registration Officer of another assembly constituency, such card shall also be considered provided the name of that elector finds place in the electoral roll pertaining to the polling station where the elector has turned up for voting. But in such cases, it should be ensured that the elector does not vote at more than one place by thoroughly checking the left-hand index finger of the elector to see that there is no indelible ink mark thereon, and by applying the indelible ink on the left index finger properly while allowing him to vote.

1.10. DUTIES OF POLLING OFFICERS IN SINGLE ELECTION

(i) First Polling Officer

The first Polling Officer will be in charge of the marked copy of electoral roll and responsible for identification of electors. On entering the Polling Station, the elector will proceed directly to the first Polling Officer. That Polling Officer will satisfy himself about the identity of the elector. **At every election, the Commission issues order regarding identification of electors. Presiding Officer should go through the order carefully. The electors are required to produce EPIC or any of the other identification document as may be specified in the Commission’s Order.** When an elector is allowed to cast vote at the Polling Station, a line will be drawn, in red ink, diagonally across the box containing the particulars pertaining to the elector in the marked copy of photo electoral roll. Further, for easy verification and calculation of number of male and female voters, the serial number of voters will be rounded off in the case of female voter and marking a star near voter serial number in case of third gender. In addition to this, filling of statistics format is also the duty of first Polling Officer.

(ii) Second Polling Officer

- The second Polling Officer will be in charge of indelible ink. After the elector has been identified by the first Polling Officer, the second Polling Officer will inspect the elector’s left-hand index finger to see that it does not bear any sign or trace of

indelible ink and then put a mark with the indelible ink on the voter's left-hand index finger. The indelible ink will be applied on voter's left-hand index finger as a line with the help of brush (to be supplied) from the top end of the nail to the bottom of the first joint of the left index finger as shown in the diagram below:

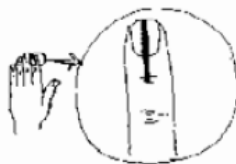

- The second Polling Officer will also be in-charge of the Register of Voters in Form 17A. He will be responsible for maintaining in that register the proper account of electors whose identity has been established and who vote at the Polling Station. The serial number (and not the name) of the elector as given in the marked copy of the electoral roll should be noted in column -2 of the Register of Voters (Form 17A). He will obtain the signature or thumb impression of each elector in that register before the elector is allowed to vote. The second Polling Officer will also issue a voter's slip to each elector after he has entered his (elector's) particulars in the Register of Voters in accordance with the procedure described in **Chapter – 4**. It should be ensured that sufficient time has elapsed after the indelible ink mark was put so that the mark dries up by the time the elector leaves the Polling Station. For this purpose, only after the mark of indelible ink is applied, signature/thumb impression may be obtained in the Register of Voters.
- If an elector refuses to put his signature or thumb impression on the Register of Voters, he shall not be permitted to vote and an entry 'Refused to vote' will be made in the 'Remarks' column of the Register of Voters. The Presiding Officer will have to sign below such entry. However, if an elector after his electoral roll number has been duly entered in column -2 of the Register of Voters in Form 17A and has put his signature or thumb impression thereon as required under sub-rule (1) of rule 49L, decides not to record his vote, a remark to this effect – 'Refused to vote/Left without voting' shall be made against the said entry in Form 17A by you and the signature or thumb impression of the elector shall be obtained against such remark. In such case it shall not be necessary to make any change in the serial number of the elector or of any succeeding elector in column 1 of the Register of Voters (Form 17A).

(iii) **Third Polling Officer**

- The third Polling Officer will be in-charge of the Control Unit of the voting machine. He will be seated on the same table where the Second Polling Officer sits. The third Polling Officer will allow the elector to proceed to the Voting Compartment only based on the voter's slip issued by the second Polling Officer and strictly in accordance with the serial number indicated in that slip. The Polling Officer in-charge of the Control Unit shall ensure that mark of the Indelible Ink is intact on the finger of electors, before pressing the ballot button of Control Unit. He will activate the Ballot Unit(s) kept in the Voting Compartment by pressing the 'Ballot' button on the Control Unit as explained in detail in **Chapter – 4**. Before allowing the elector to proceed to the Voting Compartment, he will also check and ensure that the elector's left-hand index finger still bears a clear indelible ink mark. (If the indelible ink mark is found removed, the mark may again be made on the index finger).
- Where the number of electors assigned to a Polling Station is small, the duties of the third Polling Officer can be performed by the Presiding Officer himself, thus making a further economy in the formation of Polling Parties

(iv) In the event of shortage of polling staff in any District/Constituency, then in

such places, the Polling Party may consist of a Presiding Officer and two Polling Officers as against the three Polling Officers which is the standard form. In that case, the duty of the First Polling Officer will also include application of indelible ink on the finger of the voter, after identification of the voter. The second Polling Officer will be the custodian of the 'CU' also in such cases, in addition to his normal duties of making the entries in Form 17A (Register of Voters) and taking the signature/Thumb impression of electors therein. It is clarified that in such cases where only two Polling Officers are used, it is not necessary to prepare the voter slip serial numbers. Instead, the second Polling Officer will activate the 'CU' and then send the voters inside the Voting Compartment exactly in the same sequence in which they sign in the Register of Voters (Form 17A). There will be no need to prepare the voters slip at the Polling Station in such cases. Further in the cases where number of Polling Officers are restricted to two, the contesting candidate should be informed in writing in advance about this. The duties to be performed by the two Polling Officers should be explained to the candidates.

- (v) In case a voter "refuses to vote" or "left without voting", and the "Ballot" button on the Control Unit has already been pressed to release voting on the Ballot Unit, either the Presiding Officer/third Polling Officer, whoever is in-charge of the Control Unit, should direct the next voter straightaway to proceed to the Voting Compartment to record his vote.
- (vi) In another eventuality, when the "Ballot" button on the Control Unit has been pressed to release voting on the Ballot Unit and the last voter refuses to vote, the Presiding Officer/third Polling Officer, whoever is in charge of the Control Unit shall put the 'Power' switch in the rear compartment of the Control Unit to 'OFF' position and disconnect the VVPAT from the Control Unit. After disconnecting the Ballot Unit and VVPAT from the Control Unit the 'Power' switch should again be put 'ON'. Now the 'Busy' lamp will go off and the 'Close' button will become functional to close the poll.

1.11. DUTIES OF POLLING OFFICERS IN SIMULTANEOUS ELECTION

(i) **First Polling Officer**

He will be identifying the electors and will be in-charge of marked copy of the electoral roll.

(ii) **Second Polling Officer**

He will be in-charge of the indelible ink and voters register.

(iii) **Third Polling Officer**

He will be in-charge of the voter's slip.

(iv) **Fourth Polling Officer**

He will be in-charge of the Control Unit for Lok Sabha Election.

(v) **Fifth Polling Officer**

He will be in-charge of the Control Unit for State Assembly Election.

(vi) **IMPORTANT DUTIES OF 4TH AND 5TH POLLING OFFICERS**

It may appear that the 4th and 5th Polling Officers have been given a very easy job. On the contrary, the success of simultaneous election depends on their alertness. Their job is not only to simply press the 'Ballot' button to activate the voting machine, but they have also to ensure that each elector votes in his/her turn exactly in the same serial order as has been given in the voters' slip. They have also to keep a constant watch to ensure that when they direct any elector to go and vote, the elector goes into the correct Voting Compartment and votes accordingly. Due to ignorance or otherwise, if any elector seems to be not sure as to where to go and what to do after he has been allowed to vote, it is the duty of these two Polling Officers to ensure that the elector follows the correct procedure. Specially, during the first hour of poll, when there is usually a lot of rush, they must keep themselves cool and see that the voting proceeds smoothly. Whenever there is a respite and in any case after every one hour of poll, they should also tally the total votes polled with the total number of voters as shown in the voters register and as displayed in the two Control Units.

1.12. PRESIDING OFFICER'S DUTY—BROAD OUTLINE

As Presiding Officer, you are over all in-charge of the Polling Station. Your duties are to:

- (i) Not miss any of the training classes.
- (ii) Keep in ready possession all relevant instructions of the Commission.
- (iii) Fully acquaint yourself with the latest rules and procedures prescribed for the conduct of poll by EVM with VVPAT.
- (iv) Familiarize yourself thoroughly with the operation of the EVM with VVPAT and the functions of various buttons and switches provided therein.
- (v) Ensure that, while collecting election materials, all items have been handed over to you as per the list supplied along with the materials as specified in **Annexure – 3**.
- (vi) Set up the Polling Station as per specification. Place the BU and VVPAT in the respective Voting Compartments. You should have a clear idea of the arrangements to be made for setting up of the Polling Station in a proper way especially to secure secrecy of voting, regulation of voters' queue, protection of poll proceedings free from outside interference, etc. On arrival at the Dispersal centre, you should also ensure whether your Polling Station has CAPF or police arrangement. You should be aware if there is Micro-Observer and digital Camera/Web casting facility available at the Polling Station.
- (vii) Under no circumstances, the Ballot Units, or the Control Units or VVPATs should be placed on the floor. They must be kept on a table; Connect the Ballot Units and VVPATs with their respective Units.
- (viii) Demonstrate before the hour fixed for actual commencement of the poll to the candidates/agents present that the voting machines are clear and do not contain any votes.
- (ix) Conduct mock poll for Polling Agents to ensure that the EVM with VVPAT is in perfect working condition by letting the Polling Agents record a few votes randomly for each of the contesting candidate; tally the CU result and VVPAT paper slips count. The Commission's latest guideline stipulates that at least 50 votes will be cast in mock poll and at least one vote will be cast against each candidate ***including NOTA***.
- (x) Clear the mock poll result from CU and remove the mock poll slips from the VVPAT drop box. Prepare the Certificate of mock poll. **(Part – I of Annexure - 5)**
- (xi) You should be clear that according to the Commission's instructions, if there is no mock poll at a Polling Station, there shall be no poll at that Polling Station.
- (xii) Remember that the votes recorded at such mock poll must be cleared from the Control Unit of the voting machine so that no data relating to the mock poll remains in the memory of the machine and paper slips must be taken out from the VVPAT drop box, so that drop box of VVPAT is empty after the mock poll.
- (xiii) Before the first voter signs in Form 17A (Register of Voters), the Polling Officer-I shall check with the Presiding Officer and record in INK in Form 17A that **"Total in the Control Unit is checked and found to be Zero"**.
- (xiv) Ensure that on the **green paper seal** fixed in the **Control Unit for Lok Sabha election** only the candidates for Lok Sabha Election or their Polling Agents, who are present at the Polling Station at that time, affix their signatures, and similarly, on the green paper seal fixed in the **Control Unit for Assembly Election**, the candidates for assembly election or their Polling Agents alone affix their signatures.
- (xv) Demonstrate to the Polling Agents and other persons present that the marked copy of the electoral roll (copy of the electoral roll to be used for 'marking' the names of electors who are allowed to vote) does not contain any remarks other than those used for issuing postal ballot papers.
- (xvi) See that Voting Compartments have been properly arranged with appropriate posters pasted outside to indicate clearly the election pertaining to which the Ballot Unit and VVPAT is kept inside.

- (xvii) Ensure that the cables to connect the Ballot Units and VVPATs with their respective Control Units are placed in such a way that the cable is visible to everyone while also ensuring that the voters are not required to cross over them during their movements inside the Polling Station and the entire length of the connecting cable is visible to all and not hidden. It should also be ensured that the cable does not hang loose under the Voting Compartment. Tape the connecting wires of BU and VVPAT to the leg of the table with “Transparent Adhesive Tape” of half inch width in such a manner that the wires do not hang in the air so that the load of hanging wire does not impact the connecting switch of the BU and VVPAT.
- (xviii) Ensure that all the members of the Polling Party are in position well before the commencement of the poll and all the material and records are kept handy and ready to commence poll at the appointed hour.
- (xix) Prevent any member of the Polling Party or any polling agent from wandering here or there inside the Polling Station and to keep them seated in their allocated seats.
- (xx) Commence the actual poll at the stroke of the hour fixed for commencement of poll. Before commencing the poll, the candidates, or their agents, who are present at the Polling Station and the Polling Officers, should be briefed about the maintenance of secrecy of vote. The provisions of Section 128 of the Representation of the People Act, 1951 should be read out and brought to their notice.
- (xxi) Read out the declaration aloud to the hearing of all persons present in Polling Station and sign on the declaration and obtain signature of such Polling Agents as are present and willing to affix the same. If any Polling Agent declines to affix his signature, the Presiding Officer should record the names of such Polling Agent without declaration and make a declaration in a prescribed form about the demonstration of the voting machine, marked copy of the electoral roll and the Register of Voters and obtain signature of candidates or their Polling Agents [Annexure – 6].
- (xxii) During the progress of poll, keep a close watch on the movements of the voters and be alert and watchful so that no voter goes away without voting and go on recording the relevant events as and when they occur in the Presiding Officer’s Diary [Annexure – 7].
- (xxiii) Ensure that during the first hour of the poll when polling is generally brisk, no member of the Polling Party shows any slackness in the duties allocated to him.
- (xxiv) Check the total votes casted periodically with the Control Unit and ensure that voters have voted according to their serial numbers given on the voter’s slip.
- (xxv) Ensure that in simultaneous election, copies of Form 17C [Annexure – 8] for parliamentary election are supplied to Polling Agents of the candidates in Parliamentary Constituency only and copies of Form 17C [Annexure – 8] for the Assembly Election are given only to the agents of candidates of assembly constituency.
- (xxvi) At regular intervals check the Ballot Unit(s) and VVPAT to ensure that the voters have not tampered with it in any manner. You have a right under rule 49Q of the Conduct of Elections Rules, 1961 to enter the Voting Compartment in such cases and to take such steps as you may consider necessary to ensure that the Ballot Unit is not tampered with or interfered with in any way and that the poll progresses smoothly and orderly. However, be careful that, whenever you enter the Voting Compartment, do not enter the compartment alone. You should permit and take one or two or more Polling Agents present at the Polling Station to accompany you.
- (xxvii) To regulate the proceedings in the Polling Station for peaceful and smooth conduct of poll, much tact is required, but at the same time you should be firm and impartial. **If any incident takes place at the Polling Station and is not reported by you, but reported from any other source, the Commission may take a serious view and initiate action against you.**
- (xxviii) Close the poll at the hour fixed for the purpose by the Election Commission, even if the commencement of poll was delayed for any reason. However, all voters present at the Polling Station at the closing hour of poll shall be allowed to vote even if that means

continuing of poll for some more time. It should also be ensured that after the closing hour of poll nobody joins the queue of voters. For this purpose, you should distribute numbered slips, signed by you, to all the voters standing in the queue starting such distribution of slips from the last person standing in the queue. After all electors have cast their votes and no one is left, then the Polling Officer shall put a red line after entry of last sign there giving date and time. Press 'Close' button of the Control Unit after all voters in queue cast their votes. **You should loudly announce about the closing hour of the poll before 15 minutes of the closing hour.**

- (xxix) Ensure that at the close of poll, you are required to prepare an 'Account of Votes Recorded' in Part I of Form 17C [**Annexure – 8**] and obtain the signature of the Polling Agents in the column specified for the purpose in that Form. Authenticated copies of such account of votes recorded are required to be given to the polling agent of each candidate present at the Polling Station. You are also required to make a declaration regarding furnishing of such copies to the candidates' agents in the form prescribed by the Commission.
- (xxx) After the close of poll, the voting machine with VVPAT and all election papers should be sealed and secured in the manner prescribed by the Election Commission. Candidates or their agents present at the Polling Station shall also be allowed to affix their seals, if they so desire, on the voting machine & VVPAT and the election papers, in addition to your seals. You should carefully follow the relevant instructions about the sealing and securing of voting machines & VVPAT and election papers so that no mistake is committed.
- (xxxi) It is your personal responsibility to hand over the duly sealed and secured voting machine & VVPAT and all election papers to the officer responsible for the collection thereof, under proper receipt.
- (xxxii) Your duties, in brief, at various stages are given in **Annexure - 9** under five different heads for your ready reference and convenience.
- (xxxiii) Check Memo: To ensure that you have fulfilled the various statutory requirements in connection with the election, the Election Commission has drawn up a Check Memo for you, which is given in **Annexure - 10**. The said check memo should be properly maintained by you.
- (xxxiv) You are permitted to carry your mobile phones in silent mode.

1.13. CLOSING THE POLL

- (i) The Presiding Officer should ensure that the poll is duly closed at the end of the polling hour as per the prescribed voting procedures. After the last voter has voted as per the above procedure, he must press the 'CLOSE' button on the Control Units. After prescribed forms have been carefully and duly filled, he must switch off the Control Unit and disconnect the VVPAT from Ballot Unit(s) and Control Unit and seal them in their respective carrying cases. A Report to this effect is to be prepared as per **Part III of Annexure - 5**.
- (ii) The Presiding Officer shall remove the power pack (battery) from VVPAT in the presence of Polling Agents after the close of poll. Only after removal of power pack (battery) from VVPAT the carrying case of VVPAT shall be sealed in the presence of Polling Agents. The power pack so removed shall be submitted at the reception centre as per the prescribed procedure. (Refer to latest edition of EVM Manual)
- (iii) In the case of simultaneous election, the papers should be prepared and sealed separately. At simultaneous elections Presiding Officer should ensure that the carrying cases of all the units have Identity Stickers of the concerned elections prominently pasted on the outside. He/She should also ensure that the Ballot Units, Control Units and VVPATs are placed only in their respective carrying cases with the election identity label firmly pasted. Further, he should also fix the duly filled in address tags to the respective carrying cases.

- (iv) Presiding Officer shall hand over all the sealed Units and election records to the Returning Officer, at the Reception Center.

1.14. SECTOR OFFICER

- (i) Sector Officers (SO) act as an interface between Presiding Officer (PrO) and the Returning Officer (RO). Presiding Officer may get any extra election material, EVM, VVPAT, power packs etc., if needed, from the Sector Officer.
- (ii) It is the duty of PrO to submit vote casting Report after every two hours to SO as well as he shall supply the information about the number of voters from vulnerable habitats / communities, who have been ticked in marked copy of Electoral Roll to SO.
- (iii) Part-IV and Part-V of the Presiding Officer's Report [**Annexure – 5**] shall be collected by the Sector Officer. Sector Officer shall submit the said Reports to the Returning Officer.

1.15. VOTER ASSISTANCE BOOTH

- (i) For each Polling Station premise/building location, irrespective of the number of polling booths, a Voter Assistance Booth shall be setup. Objective is to facilitate the voter to locate his/her Polling Station number & serial number of voters in the electoral roll. For this, Part – wise electoral roll is generated in alphabetical order. Further, alphabetical arrangement of names within a part is not divided section wise.
- (ii) The alphabetical list should preferably be printed in English. For single/double Polling Stations buildings, no separate team or Voter Assistance Booth is required. In such cases the alphabetical roll locator will be provided to the Presiding Officer for easy identification of electors in the Polling Station (in addition to the marked copy). A team of officials will be appointed by the RO for each VAB. Appointment is to be made for poll day only. Necessary seating arrangements to be made for VAB personnel.
- (iii) Signage indicating “**VOTER ASSISTANCE BOOTH**” is to be put up in such a manner that the same is conspicuous to voters as they approach the premise/building. VAB personnel will locate the booth number and serial number of every elector seeking such information.

CHAPTER – 02

SET UP OF POLLING STATIONS AND SECURITY ARRANGEMENTS

2.1. ARRIVAL AT THE POLLING STATION

You should be at the Polling Station a day before the poll with your party as per instructions of DEO or RO. Do not open the Electronic Voting Machine and VVPAT. Further you should not accept the hospitality of the local people.

2.2. ABSENCE OF POLLING OFFICER

Due to some unforeseen circumstances, if any Polling Officer appointed for your Polling Station is absent or not able to perform his/her duty, the Presiding Officer is empowered to appoint any person who is present at the Polling Station, to be the Polling Officer to take his place and inform the District Election Officer accordingly. But such person should not be a person who has been employed by or on behalf of, or has been otherwise working for, a candidate in or about the election.

2.3. SET UP OF POLLING STATION FOR SINGLE ELECTION

On your arrival at the place where the Polling Station is to be set up, inspect the building proposed for the purpose and plan the set up. If the Polling Station has already been set up, inspect the Polling Station itself. (Diagram of Model Polling Station Showing the layout when the polling party consist of 3 Polling Officers at a single election, is given below) Presiding Officer can make minor modifications in the actual set up of the Polling Station, if considered necessary; but make sure that:

- There is enough space for the voters to wait outside the Polling Station;
- There is separate waiting space for men and women as far as practicable;
- There is separate entrance and exit for voters;
- Even if there is only one door to the room housing the Polling Station, separate entrance and exit can be provided with the help of bamboos and ropes in the middle of the doorway.

POLL DAY: LAYOUT OF POLLING STATION

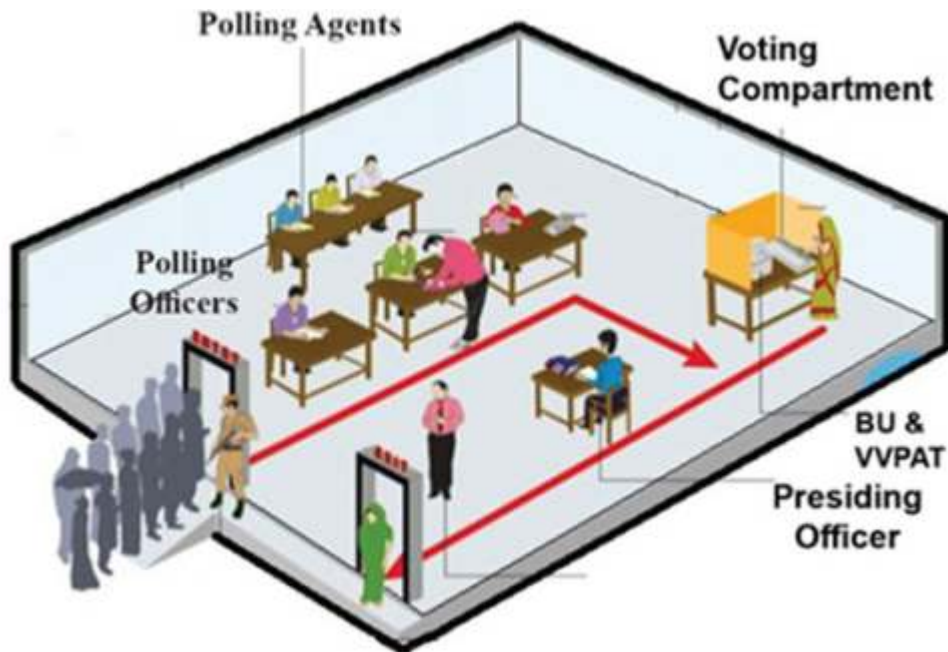

- (ii) Make sure that high wattage incandescent bulbs/tube-light should not be placed over or in front of Voting Compartment (as VVPAT may go into error mode in excess light). Voting Compartment should be placed in such a way that:

- Sufficient light is available inside the Voting Compartment,
 - No direct lighting is placed over or in front of the Voting Compartment,
 - Secrecy of voting is not violated; and
 - Voting Compartment is not placed near the window/door.
- (iii) There should be easy flow of voters from the time they enter the Polling Station till the time they leave it and there is no crisscross movement within the Polling Station;
- (iv) The seating arrangement of all the Polling Officers should also be such that they are not in a position to see the voter actually recording his vote by pressing particular button;
- (v) The Voting Compartment should be located at a sufficient distance from the table where the Control Unit shall be kept. The interconnecting cable between the VVPAT and the Control Unit has a length of approximately five meters. Therefore, the Voting Compartment should be reasonably distanced. Also, the cable should be so routed that it does not obstruct the movement of voters inside the Polling Station, and they do not tread or trip over it, but the entire length of the cable should be visible and under no circumstances be concealed under the cloth or under the table. Tape the connecting wires of BU and VVPAT to the leg of the table with “Transparent Adhesive Tape” of half inch width in such a manner that the wires do not hang in the air so that the load of hanging wire does not impact the connecting switch of the BU and VVPAT. While placing the Ballot Unit(s) and VVPAT in the Voting Compartment, it must be ensured without fail that secrecy of voting is not violated. VVPAT should be placed to the left side of the 1st Ballot Unit.
- (vi) It must be ensured that the Voting Compartment has been made of corrugated plastic sheet (flex-board) of steel grey color (which is opaque and reusable). The Voting Compartment has three folds, and each fold is of the dimension 24”X24”X30” (Length X Width X Height) if one Ballot Unit is used. If more than one BU is used in Poll, the Width of the Voting Compartment may be increased 12” for each additional Ballot Unit. Where additional BU is used, arrange it in the manner as per **Annexure - 23**. While placing the EVM in the voting compartment, ensure that the secrecy of voting is not violated and ensure that it is not near a window or the door of the polling station. (Reference: Latest Manual on EVM and VVPAT) It must be placed away from the window/door.

2.4. SET UP OF POLLING STATIONS FOR SIMULTANEOUS ELECTION

- (i) A layout plan of the Polling Station where two (2) sets of EVM and VVPAT are to be used for simultaneous poll (i.e., for Lok Sabha and Vidhan Sabha elections together) is given below. In the layout, only one door for entry and exit of voters has been shown. However, if the room where the Polling Station has been set up has two doors, the entry and exit may be arranged from different doors.

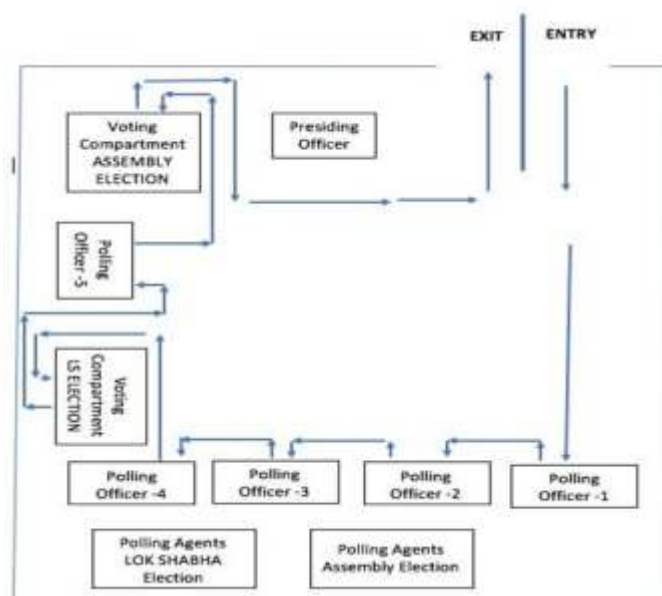

- (ii) There shall be two (2) separate Voting Compartments – one for keeping the BU(s) and VVPAT of the Lok Sabha election and the other to keep the BU(s) and VVPAT of the Vidhan Sabha election. A Notice with bold letters on each of the “Voting Compartments” with the words ‘**VOTING COMPARTMENT – LOK SABHA ELECTION**’ along with **YEAR** and **CONSTITUENCY** and “**VOTING COMPARTMENT – VIDHAN SABHA ELECTION**’ shall be pasted on each of the Voting Compartments.
- (iii) Voters must vote in secrecy and for this purpose, the BU(s) and VVPATs are required to be kept in Voting Compartments. Voting Compartment has three sides covered. The BU and VVPAT is to be placed inside the Voting Compartment on a table in such a way that voters do not have any difficulty in recording their votes. The Voting Compartment should be located at sufficient distance from the table where the CU shall be kept and operated. The interconnecting cable between the VVPAT and the CU should be so routed that it does not obstruct the movement of voters inside the Polling Station, and they do not tread or trip over it, but the entire length of the cable should be visible and under no circumstance be concealed under the cloth or under the table. It has to come out from the back portion of the Voting Compartment through an aperture cut out at the bottom of the back portion of the Voting Compartment. However, this aperture in the Voting Compartment should also not be so wide as to violate the secrecy of voting. While placing the BU(s) and VVPAT in the Voting Compartment, it must be ensured without fail that secrecy of voting is not violated. For this purpose, it must be ensured that it is not near the window or the door of the Polling Station. VVPAT should be placed to the left side of the 1st Ballot Unit. It should be placed away from the window/door but there should be enough light to enable voters to read the ballot on BU(s). It should be ensured that VVPAT is not placed under direct light.

2.5. VOTING PROCEDURE FOR SIMULTANEOUS ELECTIONS

- (i) The voters when they enter the Polling Station will proceed to the first Polling Officer. The first Polling Officer will identify the electors by verifying his EPIC or other documents as prescribed by the Election Commission.
- (ii) The voter will then move to second Polling Officer. The second Polling Officer will first apply the indelible ink mark on his left-hand index finger and ask him to sign or put thumb impression in the voter’s register. If the voter puts his thumb impression, the Polling Officer should ask the voter to wipe off the residuary stamp pad ink from his thumb with a piece of wet cloth kept on the table for this purpose.
- (iii) When the second Polling Officer will apply the indelible ink mark and take the signature or thumb impression of the voter in the register, the third Polling Officer who will be sharing the table with the second Polling Officer, will prepare two identical voter slips – one on white paper and the other on pink paper and after examining the finger of the voter to ensure that the indelible ink mark is duly applied and not erased will hand over both
- (iv) **VOTING FOR LOK SABHA:** After receiving the two voter slips, enabling him to vote for Lok Sabha and Vidhan Sabha elections respectively, the voter will go to the fourth Polling Officer who is in-charge of the CONTROL UNIT FOR LOK SABHA ELECTION. He will hand over the white voter slip to the fourth Polling Officer. After satisfying that it is the turn of that voter to vote, the fourth Polling Officer shall press the ‘allot’ button on the Control Unit for the Lok Sabha election kept on his table and direct the voter to go into the Voting Compartment for Lok Sabha election. While doing so, the fourth Polling Officer should inform the voter that after voting for Lok Sabha, he should go with the pink voter slip to the fifth Polling Officer to vote for assembly election. The voter will then enter the

Voting Compartment for Lok Sabha election and vote for Lok Sabha election by pressing the blue button of the candidate of his choice on the Ballot Unit kept inside.

- (v) **VOTING FOR VIDHAN SABHA ELECTION:** After the voter has voted for Lok Sabha election, it should be ensured that the voter goes to the fifth Polling Officer in-charge of Control Unit for Vidhan Sabha election. After taking the pink voter slip from the voter and ensuring that now it is their turn to vote, the fifth Polling Officer shall activate the machine by pressing the 'Ballot' button on the Control Unit for assembly election and direct the voter to go inside the Voting Compartment for assembly election to vote. The fifth Polling Officer will also inspect the indelible ink mark to ensure that the same is intact.

2.6. OTHER PRECAUTIONS

- (i) If sufficiently large number of 'pardanashin' (burqa-clad) women electors are assigned to your Polling Station, you should make special arrangements for their identification and application of indelible ink on the left index finger by a lady Polling Officer in a separate enclosure having due regard to privacy, dignity, and decency. For such special enclosure you may use locally available but inexpensive material.
- (ii) If more than one Polling Station is in the same building, you should satisfy yourself that necessary arrangements are made for segregating the voters and making them wait in different parts of the space in front of each Polling Station without causing confusion.
- (iii) There should be three queues at the Polling Station: one for male voters, one for female voters and third one for the persons with disabilities and Senior Citizens. One male elector should be allowed to vote per two female voters.
- (iv) If the Polling Station is located in a private building/private institution, the building and the area around it up to a radius of one hundred meters should be under your control. No person (chowkidar/guard or anybody else) connected with the owner, whether armed or unarmed, should be allowed to remain either at the Polling Station or within a radius of two hundred meters around it. The security arrangements at the Polling Station and within the above area will be entirely the responsibility of the police under your control.
- (v) No photos of leaders or symbols of any political party or slogans having a bearing on elections should be exhibited and if they are already there, you should take steps to remove them and keep them away, till the poll is over.
- (vi) No cooking or lighting of fire for any purpose should be allowed inside the Polling Station during the day of the poll.

2.7. DISPLAY OF NOTICE

- (i) Display prominently outside each Polling Station:
- A notice specifying the polling area and the particulars of electors to be served by the Polling Station; and
 - A copy of the list of contesting candidates in Form 7A.
- (ii) The language of the notice should be the same as for the list of contesting candidates and the order of the names should also be the same as in the list of contesting candidate.
- (iii) Voter Facilitation Posters should be displayed on the outside wall, near the entrance of each Polling Station.
- (iv) A printed sample of EVM Ballot Unit pasted on the Cardboard (real size) dummy ballot paper to be used to facilitate voters.
- (v) Message to be displayed – **“YOU ARE UNDER WEB CAMERA / CCTV SURVIELLANCE.”**

2.8. PERSONS ENTITLED TO ENTER THE POLLING STATIONS

- (i) In addition to the electors assigned to your Polling Station, only the following persons can be admitted into the Polling Station:
- Polling Officers;
 - Each candidate, his Election Agent and one duly appointed polling agent of each candidate at a time;
 - Media persons authorized by the Commission;
 - Public servants on duty in connection with election, Observers appointed by the Commission;
 - Micro observers, Videographers/ photographers/ staff for webcasting in the case of a critical/sensitive Polling Station;
 - A child in arms accompanying an elector;
 - A person accompanying a blind or an infirm voter who cannot move without help; and
 - Such other persons as you may from time to time admit for the purpose of identifying voters or otherwise assisting you in taking the poll.
 - The Returning Officers have been asked to issue identity cards to the contesting candidates bearing their photographs. In case a necessity arises, you may ask for its production when they visit the Polling Station. Similarly, the Election Agents of the candidates can be asked to produce the duplicate copy of their appointment letter, which is attested by the Returning Officer and also bears the photograph of the Election Agent.
- (ii) You should note that the term “Public servant on duty in connection with election” does not normally include police officers. Such officers (whether in uniform or in plain clothes) should not (as a general rule) be allowed to enter inside the polling booth. You may, however, call them in occasionally for the maintenance of law and order or some similar purpose, whenever the necessity arises. Their presence in the polling booth without any compelling reason has on occasions given rise to complaints by some candidates or parties who have alleged that their agents had been over awed by unnecessary show of force.
- (iii) Similarly, security personnel, if any, accompanying an elector or candidate or his Election Agent or polling agent should also not be allowed to enter the Polling Station except the security personnel for the Z+ protected, that too only a single plain clothed security personnel with concealed arms.
- (iv) You should also note that the expression, “Public servant on duty in connection with election” does not also include the Ministers, State Ministers and Deputy Ministers of the Union and the States. The Ministers, State Ministers and Deputy Ministers of the Union and the States, who have been given security cover at the State expense are not allowed to function as Polling Agents as per Commission’ directions.
- (v) As per standing instructions, the Security personnel accompanying Ministers or political functionaries, who enter the Polling Station in their capacity as candidates for elections or as electors, shall not be allowed entry inside the Polling Station. They can wait to stand at the door of the Polling Station but shall not; in any circumstances do any act amounting to interference-vice in the conduct of poll.
- (vi) Entry of persons should be strictly regulated as detailed above; otherwise, smooth, and orderly conduct of poll may be vitiated. You should allow only three or four electors to enter the Polling Station at a time.
- (vii) If you have a reasonable doubt about the presence of any person, about his/her credentials you have a reasonable suspicion, in the polling booth, you can have him searched, if necessary, even though the person concerned may be in possession of a valid authority letter to enter the polling booth.
- (viii) In the performance of your duties, you are only bound by the instructions of the Election

- (ix) If you have engaged any local officer or a woman attendant for helping you in the identification of electors or to assist you otherwise in taking the poll, they should normally, be seated outside the entrance of the Polling Station. He/she should be admitted into the Polling Station only when he/she is required for identification of a particular elector or for assisting you for a particular purpose in connection with the taking of the poll. No one inside the Polling Station should be allowed to influence or try to influence the electors by words or gestures to vote in a particular way.

2.9. APPOINTMENT AND REVOCATION OF POLLING AGENTS

- (i) Each candidate can appoint one polling agent and two relieving Polling Agents at each Polling Station. However, only one polling agent of a candidate should be allowed inside the Polling Station at any given point of time.
- (ii) The candidate or his Election Agent can also revoke the appointment of a polling agent. The revocation of appointment of a polling agent is made by the candidate or his Election Agent in the prescribed form. (Refer to latest edition of Handbook on Polling Agents)
- (iii) If the appointment of any polling agent is revoked or if any polling agent dies before the close of the poll, the candidate or his Election Agent can appoint another polling agent at any time before the poll is over. (Refer to latest edition of Handbook on Polling Agents)

2.10. QUALIFICATION FOR APPOINTMENT AS POLLING AGENTS

- (i) The Polling Agents, who are appointed by contesting candidates, shall be ordinarily resident and electors in the same polling booth or at most from the neighbouring Polling Station falling in the same constituency. The Commission has further relaxed the norms and now Polling Agents can be appointed from amongst any elector of the same Assembly Constituency only if there is a difficulty in appointing Polling Agents from same polling booth. Polling Agents must have Elector Photo Identity Cards (EPIC) or any other recognized identification device issued by the Govt or any Govt agency which bears his/her identity.
- (ii) In case elector, who has been proposed to be appointed as Polling Agent by the contesting candidate, does not have his Elector Photo Identity Card, the Returning Officer shall make necessary arrangements for issuing of Elector Photo Identity Card to such elector on written request from the concerned contesting candidate or his Election Agent. You must ensure that all the Polling Agents display their Elector Photo Identity Cards or any other recognized identity prominently on their persons on the day of poll for easy and quick identification.
- (iii) There is no restriction on appointing Gram Panchayat Pradhan/Gram Panchayat Sarpanch/Panchayat members, Councilors or Members of Municipal Corporation or Municipality and local persons, as Polling Agents

2.11. PRODUCTION OF APPOINTMENT LETTERS BY POLLING AGENTS

- (i) Every polling agent must produce before you the appointment letter in Form- 10 by which the candidate or his Election Agent has appointed him. Check that the appointment is for your Polling Station. After it is confirmed that polling agent has been appointed for your Polling Station, the polling agent should complete the document and sign the declaration therein in your presence and then deliver it to you before he can be admitted into the Polling Station. To ensure not more than one Polling Agent or relieving agent of a particular candidate remains present inside the Polling Station at any given point of time, PrO shall issue Entry Pass (**Annexure-12**) in favor of the polling agent of each candidate and maintain a record of entry passes as prescribed in the format as enclosed in Annexure 13. and keep it in the envelope for depositing with other election material at the Receiving Centre along with other documents. In case of any doubt about the genuineness of the appointment letter in the said Form 10 of any Polling Agent presented before you, you should compare the specimen signature of the candidate/his Election Agent with their specimen signatures as provided by the Returning Officer.

2.12. ATTENDANCE OF POLLING AGENTS

- (i) The Polling Agents of the candidates should be asked to reach the Polling Station at least **90 minutes** before commencement of poll, so that they are present when you are going through the preliminaries. If any part of these preliminaries has already been gone through and missed by any latecomer, the proceedings need not be commenced de novo (from the very beginning) to accommodate any latecomer.
- (ii) The law does not specify any time limit for the appointment of Polling Agents and even if a polling agent turns up late at a Polling Station, he should be allowed to participate in the further proceedings at the Polling Station.
- (iii) A 'Polling agents/ relieving agents movement sheet' should be maintained at each Polling Station, in which each and every polling agent shall be required to sign indicating the time at which he/she came to Polling Station and also left the Polling Station. Presiding Officer should handover this sheet after poll at the EVM reception centre along with other documents. A sample of 'Polling agent/relieving agent' movement sheet' is available at **Annexure - 11**.
- (iv) The telephone nos. of RO/AROs/Key Police Officers/Sector Officers/Control room shall be displayed at the Polling Stations so that if Polling Agents have any complaint, they can call them for immediate intervention.

2.13. PASSES FOR POLLING AGENTS

Give every polling agent, who is admitted into the Polling Station, a permit or entry pass on the authority of which he can come in and go out of the Polling Station as may be necessary. However, it should be ensured that the Polling Agents do not take the copy of the electoral roll outside the Polling Station. Further, the Polling Agents may be allowed to go out of the Polling Stations even after 3.00 pm to attend the nature' call, etc. and come back inside the Polling Station. However, it may be ensured that only the polling agent or his substitute can be present inside the Polling Station at a time. The Presiding Officer shall brief the Polling Agents to remain present in the Polling Station till the voting is over to oversee the sealing procedure of EVMs and sign the declaration, etc. As per the standing instructions of the Commission, Polling Agents shall not be allowed to take cellular phones, cordless phones, wireless set etc., in any case inside the Polling Stations. Under no circumstances the agent can be allowed to send slips outside indicating the Serial. no. of the voters that have voted or not voted.

2.14. SEATING ARRANGEMENT OF POLLING AGENTS IN THE POLLING STATION

- (i) The set-up of Polling Station should be made in such a way that the Polling Agents are seated inside the Polling Stations so that they may see the face of an elector as and when he enters the Polling Station so that they can challenge the identity of the elector, if needed. They should also be able to watch entire operation at the Presiding Officer' table/the table of third Polling Officer, where the control unit is kept and also see the movement of the elector from the Presiding Officer' table/the table of third Polling Officer, as the case may be, inside the Polling Station including his/her movement to the Voting Compartment and his/her exit from the Polling Station after recording his/her vote. But they should not, in any event, be seated in a place where they have the chance of seeing voter recording his/ her vote which would compromise secrecy of voting. For this purpose, it will be preferable if you give the Polling Agents seats closely behind the Polling Officer in charge of marked copy of the electoral roll. Wherever this is not practicable because of the situation of the door for entrance, they may be given seat just opposite the Polling Officers.
- (ii) In case of a Polling Station, which has very small & insufficient space or where the respective constituency is having abnormally large number of contesting candidates warranting the presence of a large number of Polling Agents, in such cases where Polling Agents can not be accommodated, Observer(s) shall be consulted for appropriate advice and consent of the Observer(s) shall be obtained. Presiding Officer may consult with SO/ RO for their arrangement.

(iii) According to the latest instructions of the Commission, the seating order at the Polling Station for the Polling Agents of candidates shall be guided by the following categories of priorities, namely: -

- Candidates of recognized National Parties;
- Candidates of recognized State Parties;
- Candidates of recognized State Parties of other States who have been permitted to use their reserved symbols in the constituency;
- Candidates of Registered Unrecognized Parties; and
- Independent Candidates

2.15. SMOKING PROHIBITED INSIDE POLLING STATION

Smoking is strictly prohibited inside the Polling Station. You must, therefore, ensure that nobody smokes inside your Polling Station.

2.16. FACILITIES TO PRESS REPRESENTATIVES AND PHOTOGRAPHERS AND VIDEOGRAPHY AT THE POLLING STATION

- (i) The Commission has issued instructions for videography/photography of critical events of the election process and at critical and vulnerable Polling Stations. In deference to the suggestion of the Hon'ble Supreme Court, the Commission has now instructed that videography/photography of the poll proceedings may be carried out inside the polling station also in consultation with the Observer. However, proper care shall be taken to ensure that while doing the videography, the same does not violate the secrecy of vote, i.e., it should be ensured that a voter recording vote should not be videographed or photographed. No photography/ videography shall, however, be allowed by the **media persons or by any other unauthorized persons** inside the Polling Station, to maintain general order and secrecy of vote.
- (ii) Similarly, there is no objection to any photographer taking photographs of a crowd of electors lining up outside the Polling Station subject to the maintenance of peace and order. He should not, however, in any circumstances be allowed to take photographs inside the Polling Station of the actual process of a person casting his/her vote in the Voting Compartment. At the same time, nobody will be allowed to take a photograph of an elector recording his/her vote on the Ballot Unit of the voting machine in any circumstances.
- (iii) Neither the Chief Electoral Officer nor the Returning Officer is empowered to authorize any person who is not an elector or who is not required to assist you in taking the poll, to enter a Polling Station. Any such person, including publicity officials of the State Government, should not be allowed inside a Polling Station without a letter of authority from the Commission.

2.17 PHOTOGRAPHY/VIDEOGRAPHY

Use of digital photography/videography in the Polling Station was initiated on the suggestion of the Hon. Supreme Court (Judgment dated 11.01.2005 in Civil Appeal No. 9228 of 2003- Janak Singh vs Ram Das Rai & others). The Commission directs that photography may be carried inside the Polling Stations to photograph electors and cover poll proceedings. The Commission has also directed that all critical events during the entire course of election shall be videographed.

- (i) There shall be no compromise on secrecy of voting in this process. It is to be done only at Polling Stations where Commission has specifically directed.
- (ii) A camera person has to capture the following: In such Polling Stations, all electors coming to cast votes not having EPIC /other ECI approved photo identity card to be captured in the same sequence as they are entered in Form 17A, photography/videography to be taken immediately after entry. Presiding Officer has to ensure that there shall be no photography/videography in the Voting Compartment area.

- (iii) Other critical events to be captured in photo/video are:
- Mock poll and sealing of EVM and VVPAT before start of poll
 - Positioning of Voting Compartment. This should be taken before commencement of poll.
 - Photo showing presence of Polling Agents.
 - Photos of electors in case of Challenged / Tendered Votes/Missing voters as per ASD list;
 - Voters waiting outside at the close of scheduled hours of poll and last voter in the queue.
 - Visits of Sector Officers, Observers, and other electoral functionaries or any important person including the Candidates.
 - Apart from recording the events like mock poll and commencement of poll, the presence of CAPF/Police personnel should also be recorded by clicking a photograph of the security personnel standing in front of the board of the Polling Station.
 - Attempts, if any, of intimidation of voters
 - Attempts, if any, of inducement/bribing of voters
 - Canvassing within 100 meters of Polling Station
 - Assured Minimum Facilities at the Polling Station
 - Any dispute of any nature at the Polling Station
 - Any other processes or events specifies by DEO/RO
- (iv) At the end of the poll, the photographer/videographer will sign a declaration as follows: “I have captured photographs /video of all electors who voted at Polling Station number ----- on date-----and total number of photographs in the camera are-----”.

2.18 USE OF WEBCASTING AT POLLING STATION

- (i) In order to bring transparency and efficiency in the conduct of elections, the Commission has directed that webcasting be effectively used for poll day monitoring. The objectives of webcasting are
- to view the poll proceedings in real time by the Election Commission of India, the Chief Electoral Officer, the District Election Officer, the Returning Officer and the viewing team at control room.
 - to effectively monitor the polling process and deter the trouble mongers and mischief makers, imbibe confidence in the mind of electorates, bring in transparency and impartiality in the polling process.
- (ii) During webcasting in Polling Stations, the camera should be placed in such a manner that it captures clear visibility of the following:
- Voters in queue
 - Process of Identification of voters by Polling Officer.
 - Application of indelible ink on finger
 - Initialization of Control Unit by Presiding Officer after satisfactory identification of voter.
 - Voters visit to Ballot Unit for casting vote wherein camera should not cover face of Ballot Unit so that voter secrecy is preserved under all conditions.

- (iii) There shall be webcasting in all critical Polling Stations and Polling Stations in vulnerable areas or at least 50% of total Polling Stations including auxiliary Polling Stations whichever is higher.
- (iv) There should also be a bold display of the message **“YOU ARE UNDER WEB-CAMERA/CCTV SURVIELLANCE”** at the Polling Station.
- (v) Further, it must be ensured that in the above frame work used for web casting advertisements of any kind are not displayed.

2.19. FACILITIES TO OBSERVERS APPOINTED BY THE COMMISSION

- (i) The Commission appoints observers for monitoring of elections. They are statutory authorities appointed by the Commission under Section 20 B of the Representation of the People Act, 1951.
- (ii) During the day of poll, an observer might visit your Polling Station. It is quite possible that he may start his round of the constituency with the visit to your Polling Station and may be present there when you are going through the preliminaries before the commencement of poll. You are expected to show him due courtesy and regard when he visits your Polling Station and should furnish him with such information as he may require from you for the purpose of his report to the Commission. You should also make available to the Observer, additional information, which you may be having with you over and above routine information. You are also expected to make available to the Observer/Micro-Observer the list of Absentee, Shifted and Dead voter (ASD list) at the Polling Station. The Observers have already been briefed and directed that they will only observe the poll being taken at your Polling Station but will not give you any direction. If, however, he makes any suggestion with a view to providing more convenience to electors or making the poll process at your Polling Station smoother, you should give due consideration to such suggestion. At the same time, in case, you are facing any problem or facing any difficulty at your Polling Station, you are at liberty to bring it to his notice, as he might be of help to you in solving that problem or removing that difficulty by bringing the matter to the notice of the Returning Officer or any other concerned authorities for necessary remedial action.
- (iii) The Observers will be wearing badges-issued by the Commission on their person and will also be carrying appointment letters and authority letters issued by the Commission. The observers should be requested to sign the ‘Visit Sheet’, which is provided to you, stapled along with the Presiding Officer’s Diary. You shall deposit the same after the end of the poll along with the Presiding Officer’s Diary.

2.20. MICRO OBSERVERS

- (i) Micro Observers, are appointed as one of the non-CAPF measures, and can be deputed for critical Polling Stations on the day of poll. Micro Observer would directly be working under the control and supervision of the general observer. The responsibilities and tasks assigned to Micro Observer revolve around reporting deviations in the polling process from the assigned Polling Station to the General Observer of the constituency. The micro-observers are expected to reach the Polling Station **90 minutes** before the commencement of the poll and remain deployed at the Polling Station throughout the day. He must assess the preparedness for the poll and during the poll day he would regularly note down the important points on the pre- printed Proforma, but in no case the micro-observer will act as Presiding Officer or the Polling Officer or give any directions to them. His task is to observe that election process is being carried out in a free and fair manner and there is no vitiation of any kind.
- (ii) In a Polling Station location having more than one critical Polling Station, the Micro Observer shall be responsible for all the critical Polling Stations at that location. The Micro Observer shall divide his time between Polling Stations and visit all the Polling Stations within the same location at frequent intervals. He shall make it known to the Polling Agents at each Polling Station that he is available in case they want to bring anything to his notice.

- (iii) In the process of observation on the day of the poll, the micro-observer should specially observe: -
- Mock Poll procedures and sign Mock Poll Certificate Presiding Officer's Report Part-I - Mock Poll Certificate
 - Presence of Polling Agents and observance of concerned ECI instructions
 - The observance of entry pass system and access to Polling Station
 - Proper identification of electors in accordance with ECI guidelines
 - Procedure to be followed in case of Absentee, Shifted and Dead (ASD) electors
 - Application of indelible ink,
 - Noting down particulars of electors in Register of Voters 17-A,
 - Secrecy of voting
 - Sealing of EVM and VVPAT before the actual polling and after poll is over.
 - Conduct of Polling Agents, their complaints, if any, etc.
- (iv) During the poll, if the micro-observer feels that the poll is being vitiated for any reason, he will immediately bring it to the notice of General Observer through whatever means of communications available, for example, phone/mobile or wireless or any other means. If the video camera/digital camera is not deployed the Presiding Officer or Micro Observer can make use of the mobile phone (if it has camera) and click the photograph of the security arrangement and forward the image to the control room or hand over the image at the time of handing over of EVM at the respective centres.
- (v) After the poll process is over, the micro-observer will report to the Observer at the collection centre and hand over his envelope containing the report for the day personally to the Observer and brief him/her on anything of importance that had happened during the day. Observers will go through the report and if any further clarification is required then he should arrange for the micro-observer to be called for ascertaining the facts. These reports along with the scrutiny of the Register of Voters 17-A will be taken into consideration for taking a decision on repoll or on disciplinary action against any delinquent polling staff.
- (vi) Micro Observer is allowed to carry mobile phone in silent mode so that in case of any need he/she can coordinate with Observer.

2.21. WEARING OF BADGES ETC INSIDE THE POLLING STATION

- (i) No person should be allowed within the polling station or within 100 meters thereof to wear badges, emblems, etc., bearing the names of candidates or political leaders and/ or their symbols or pictorial representation thereof, as it may amount to campaigning for a contesting candidate.
- (ii) Wearables like caps, shawl etc. with political party's name, symbol or slogan is not allowed inside the polling stations on the poll day.
- (iii) The polling agents may, however, display on their person a badge showing the name of the candidate whose agents they are for the purpose of their immediate identification.

2.22. SECURITY ARRANGEMENTS AT POLLING STATIONS

- (i) During elections, the Commission deploys Central Armed Police Forces for the smooth conduct of elections. The Local State Police (including all its variants) and Central Paramilitary Forces stand deputed to the Election Commission of India at the time of elections and they come under its superintendence and control for all purposes. The Commission uses the services of personnel of these forces for smooth conduct of elections.
- (ii) As per the Commission's instructions where CAPF personnel are deployed at the Polling Station, they are used as static force outside the Polling Station.
- (iii) shall keep a watch specifically on the following: -
 - No unauthorized person is present inside the Polling Station at any time during the poll.
 - Ensure that Polling Party or the Polling Agents do not attempt to cast any vote when no voter is present inside the Polling Station.
 - No Polling Officer shall accompany any voter to the voting compartment.
 - No Polling Agent or Polling Officer shall threaten any voter or make any gesture to threaten them.
 - No arms shall be carried inside the Polling Station.
 - No silent rigging of poll process shall take place.
- (iv) If the CAPF personnel is posted at the entrance of the Polling Station discovers violation of the election process as above or observes something unusual going on inside the Polling Station, he shall not interfere in the poll process but report the same to the officer in-charge of the CAPF party at Polling Station or to the observer. The officer in-charge of CAPF party will in turn bring it to the notice of the Returning Officer and also Observer immediately in writing for further necessary action.
- (v) In the buildings which have more than one Polling Station and where only half a section of the CAPF personnel is deployed, the CAPF personnel selected for duty at the entrance of the Polling Station may be asked to oscillate from one Polling Station to another and look at what is going inside these Polling Stations and report to the officer in charge of the CAPF party or to the observer, if any irregularity is observed by him.
- (vi) Returning Officer/Observer will report cases from where adverse reports are received from the CAPF parties for further instructions of the Commission.
- (vii) **It is further clarified that the CAPF personnel posted at the entrance of the Polling Station shall not verify the identity of electors coming into the Polling Stations to cast their votes as such verification is the duty of the polling personnel.**
- (viii) According to the Commission's instructions, the CAPF personnel should not be positioned inside the Polling Station.
- (ix) In cases of disorder/disturbance in Polling Stations, Presiding Officers shall exercise the power conferred under Section 131 of the Representation of the People Act 1951 and use the presence of CAPF/State Police in case of occurrence of any untoward incident affecting the free and fair poll process. In this regard, there shall be proper coordination between Presiding Officer and CAPF/State Police Force posted at the Polling Station. Presiding Officers and CAPF/State Police Force may be briefed suitably for mutual coordination with each other during the poll process. The DEO and CP/SP shall brief the CAPF/ State Police

about this provision.

- (x) After the poll is completed, the polled EVMs, VVPATs and the Presiding Officers shall be escorted by a contingent of CAPF to the Reception Centre. Details in this regard shall be worked out by the DEO and SP in consultation with Observer in advance.

CHAPTER – 03

SETTING AND PREPARATION OF EVM AND VVPAT

3.1. INTRODUCTION TO EVM AND VVPAT



Control Unit

VVPAT

Ballot Unit

3.1.1. **ELECTRONIC VOTING MACHINE (EVM):** An EVM consists of two units, namely, Control Unit (CU) and Ballot Unit (BU).

- (i) **Ballot Unit (BU):** Ballot unit has a provision for display of the ballot paper containing the particulars of the election, the serial numbers and names and photograph of contesting candidates and the symbols respectively allotted to them. There is a blue button against the name of each candidate. By pressing this blue button, the voter can record his vote in favour of the candidate of his choice. Alongside the said button, there is also a lamp for each candidate. This lamp will glow red when the vote is recorded. Simultaneously a beep sound will also be heard. One ballot Unit caters up to sixteen buttons. Maximum twenty-four Ballot units can be cascaded together to accommodate up to a maximum of 384 candidates including NOTA. If more than four BUs are to be used, a power pack must be inserted in the 5th, 9th, 13th, 17th and 21st BU. Each BU, on its back side, has a provision for insertion of a power pack and a connector compartment for connecting additional BUs for cascading. There are two thumbwheels on the top right side of BUs to set the BU number from 01 to 24. Braille numerals have been provided on the top cover of BU, on the right side of each blue button, for the convenience of the visually challenged (blind) persons. The 5-meter-long cable attached with the Ballot Unit is used for connecting it to VVPAT or CU or other BU.
- (ii) **Control Unit (CU):** One Control Unit can record the votes polled up to a maximum of 384 candidates including NOTA. For this purpose, twenty four Ballot Units linked together are connected with one Control Unit. On the top most portion of the Control Unit, there is provision for displaying the information and data recorded in the machine, like date, time, the number of contesting candidates, total number of votes polled, votes polled to each candidate, various error messages etc. This portion is called ‘Display Section’ of the Control Unit. Below the display section, there is a compartment for fixing the battery, which runs the machine. On the right side of this compartment, there is another compartment in which there is a button for setting the machine for the number of candidates, contesting the particular election. This button is called the ‘Cand. Set’ button and the whole section of the control unit containing these

two compartments is called the ‘Candidate Set Section’. Below the Candidate set section is the ‘Result Section’ of the Control Unit. This section contains (i) ‘Close’ button on the left side, used for closing the poll, (ii) two buttons in the middle - ‘Result’ & ‘Print’. Result button is for ascertaining the result. Print button is for printout of the detailed result (For this purpose a special gadget is to be attached to the Control Unit. Presently it is not used) and (iii) ‘Clear’ button on the right side, for clearing the data recorded in the machine, when the data is no more required. In the bottom portion of the control unit, there are two buttons - one marked ‘Ballot’ and other marked ‘Total’. By pressing the button ‘Ballot’, the Ballot Unit becomes ready to record the vote and by pressing the button ‘Total’, the total number of votes recorded up to that stage (but without the candidate-wise break up) can be ascertained. This section is known as the ‘Ballot Section’ of the Control Unit.

(iii) **MEANING OF VARIOUS DISPLAYS:** Various types of display which appear on Display panel of the Control Unit and their meanings are as below:

Display on Control Unit	Meaning of Display
POWER ON LED NOT OK	CU POWER ON LED is not OK
BUZZER NOT OK	CU BUZZER is not OK
BUSY LED NOT OK	CU BUSY LED is not OK
DIGIT 02 NOT OK	Control Unit display is not OK
CHANGE BATTERY	CU battery is not within the threshold set
BU01 KEY06 NOT OK	BU 1 Candidate key 6 is not OK
BU01 READY LED NOT OK	BU 1 READY LED is not OK
BU05 WITHOUT BATTERY	BU 05 has no battery. If 5th, 9th, 13th, 17th, 21st BU is without battery, above display will appear on Display Panel
BU05 CHANGE BATTERY	BU05 battery is not OK
SELF CHECK IN PROGRESS	CU self-check status. It will display before self-diagnostics and after completion of self-diagnostics
DTE 16-07-18 TME 09-10-25	Current date in DD-MM-YY and time in HH-MM-SS format
SL NUM BCUAA00001	Internal serial number of the Control Unit mentioned on the back side of CU
CANDIDATES 10	The machine is set for 10 candidates. The candidates can vary from 03 to 384 (including NOTA)
BATTERY HIGH 95 PERCENT	The status of the Battery ‘HIGH’ depending on the battery current consumption
BATTERY MEDIUM 73 PERCENT	The status of the Battery is ‘MEDIUM’
BATTERY LOW 45 PERCENT	The status of the Battery is ‘LOW’
BATTERY MARG 26 PERCENT	The status of the Battery is ‘MARGINAL’
CHANGE BATTERY	The status of Battery is below Marginal
DISCOVERING UNITS	Units connected are discovering
DISCOVERED BU 01	After discovering units. If one BU is connected, the said display will appear on Display Panel
DISCOVERED BU01 BU02	After discovering units. If two BUs are connected, the said display will appear on Display Panel
BU01 GN1 TESTING	CU is authenticating with the BU

BU01 GN1 OK	CU authenticated the BU
BU01 GN1 NOT OK	Authentication of the BU 01 failed (message BLINK on when any key press on CU)
BU01 NOT RESPONDING	When communication time out occurs during communication with the BU or BU position (thumbwheel switch) not set properly
BU NOT CONNECTED	CU not detected BU when CU is in CLEAR state or BALLOT state
NO UNITS CONNECTED	No units are connected with CU
“INCORRECT NUMBER OF BU” and “PRESS BALLOT KEY”	When CU is in Clear state or Ballot state, if the number of BUs connected are not matching with the number of candidates set
EVM IS READY	If user presses the BALLOT key or when the correct number of BUs are connected
PRESSED ERROR BU01	If a key is stuck on the BU
DISCONNECT BU02	If the number of candidates configured is 5 (for 1 BU) and number of BUs connected is two
BU02 NOT CONNECTED	If the number of candidates configured is 26 (for 2 BUs) and number of BUs connected is 1
INVALID	A button on the Control Unit has been pressed out of sequence
FULL	The maximum number of votes (2000) for which the machine is designed has been polled
CLOCK ERROR	RTC time and date is not OK
INOPERATIVE	The Control Unit can not be further used
ELECTION EXCEEDED	Date has changed since the first vote recorded in the EVM (when time crosses midnight 12 PM)
TOTAL POLLED VOTES 50	Total number of votes polled is 50
CANDIDATE 05 VOTES 512	The candidate No. 5 has secured 512 votes
COMPUTING RESULT	RESULT is getting computed
PST 07-13-59 PET 18-30-52	Poll Starting Time and Poll End Time
POLL RESULT PDT 16-06-18	Result and Date of the Poll
DELETING POLLED VOTES	Deleting of the Polled vote from CU

- (i) When the power switch of the Control Unit is pushed upwards in ‘ON’ position, it will give a beep sound and the ‘ON’ lamp on the Display section of the Control Unit will glow GREEN and the following display will appear turn by turn of the display panel.

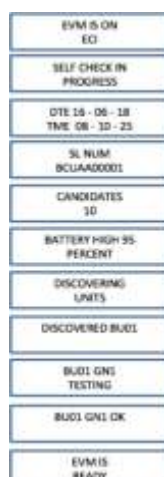

- (ii) When the 'TOTAL' button is pressed to obtain the hourly/periodically total votes polled, the following displays will appear on the Display Panel:

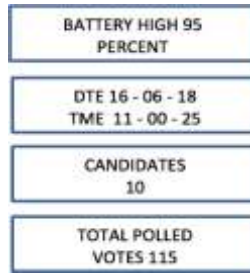

- (iii) When the 'CLOSE' button is pressed for closing the EVM, after the hour fixed for the close of the poll and the last voter has recorded his/her vote, the following display will appear on the Display Panel:

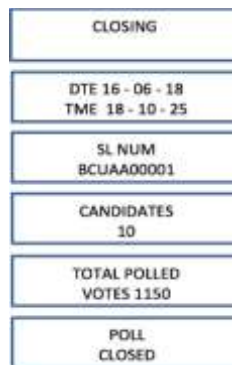

3.1.2. **VOTER VERIFIABLE PAPER AUDIT TRAIL (VVPAT):** It is an independent printer system attached with the Electronic Voting Machines (EVM) that allows the voters to verify that their votes are cast as intended. When a vote is cast by pressing the button on Ballot Unit (BU), a slip is printed by the VVPAT printer containing the serial number, name and symbol of the candidate and remains exposed through a transparent window for about 7 seconds. Thereafter, this printed slip automatically gets cut and falls in sealed drop box of the VVPAT.

VVPAT system with carrying case consists of following list of items:

- VVPAT unit with connecting cable
- Battery Pack (The battery is already placed inside the battery compartment within the VVPAT unit by Returning Officer)
- Paper Roll (The paper roll is already loaded in the paper roll compartment within the VVPAT unit and sealed with Address Tags by Returning Officer)

Action to be taken by Presiding Officers at the time of dispatch

1. Remove Ballot Unit(s), Control Unit and VVPAT carefully from the respective carrying case
2. **Ballot Unit(s)**
Check:
 - Address tags on upper and lower corners of the BU are correct and sealed properly.
 - Address Tags of BU to ensure BU(s) is/are pertaining to your assigned polling station

-
- Tally the Unit Id written on the address tag with the metallic plate/barcode on the backside of the unit.
 - Pink Paper Seal of BU is intact
 - Ballot Paper is installed properly
 - Candidate buttons up to NOTA are unmasked and remaining buttons are masked.
 - Thumb-wheel position is 01 for first BU (If more than 01 BU is used, Thumb-wheel position for 2nd BU is 02, for 3rd BU is 03 and so on)

3. Control Unit

Check:

- Address Tags of CU to ensure CU is pertaining to your assigned polling station
- Tally the Unit Id written on the address tag with the metallic plate/barcode on the backside of the unit.
- Power pack and candidate set sections are sealed properly with address tags.
- Pink Paper Seal of CU is intact
- Switch ON the CU (without connecting to BU and/or VVPAT) to check Battery status and number of contesting candidates
- Thereafter, Switch OFF the CU

4. VVPAT

Check:

- Address Tags of VVPAT to ensure that VVPAT is pertaining to your assigned Polling Station
- Tally the unit Id written on the address tag with the metallic plate/barcode on the backside of the unit.
- Paper Roll compartment is sealed properly.
- Power Pack (Battery) is installed
- VVPAT knob is horizontal (i.e. in Transportation mode)
- **DO NOT** connect VVPAT with BU and/or CU

3.2 SETTING UP OF EVM AND VVPAT BEFORE MOCK POLL AND CONDUCT OF MOCK POLL

3.2.1. CONNECTING BU, CU AND VVPAT BEFORE MOCK POLL:

- (i) Mock poll is to be started 90 minutes before the time fixed for the commencement of poll.
- (ii) Before starting the mock poll, place the **Ballot Unit(s) and VVPAT in the Voting Compartment** and **Control Unit on the Table of CU-in-Charge/ Presiding Officer**. VVPAT should be placed to the left side of the 1st Ballot Unit.
- (iii) **Before connecting BU, CU and VVPAT, it must be ensured that the ON/OFF Switch of the CU is in OFF position.**
- (iv) Plug the interconnecting cable of the VVPAT into the socket provided for the purpose in the rear compartment of the Control Unit.
- (v) Plug the interconnecting cable of the first BU into the socket provided for the purpose in the rear compartment of the VVPAT. Where the number of contesting candidates exceeds 16 (including NOTA), more than one Ballot Unit, depending upon the actual number of

contesting candidates, are to be used. All such Ballot Units to be used at a Polling Station are to be inter-linked and only the first Ballot Unit will be linked with the VVPAT unit as shown in the figure below:

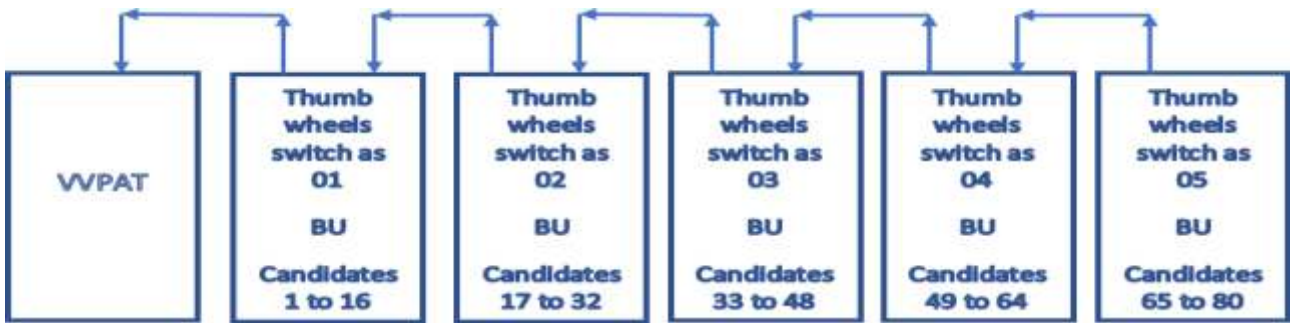

For linking a Ballot Unit with another, there is a socket provided in a compartment on the back of the Ballot Unit. The connector of the interconnecting cable of the second Ballot Unit will be plugged into the above-mentioned socket of the first Ballot Unit. Likewise, the connector of the third Ballot Unit' interconnecting cable will be plugged into the second unit and that of the fourth unit into the third unit and so on, depending on number of Ballot Units being used.

As mentioned above, the first Ballot Unit alone will be plugged into the VVPAT unit. The socket for plugging the interconnecting cable of the Ballot Unit into the VVPAT unit is provided in a compartment on the top portion of the back of the VVPAT unit.

- (vi) Route the interconnecting cable of BU/VVPAT in such a way that it does not obstruct the movement of voters inside the Polling Station and they do not tread or trip over it, but entire length of the cable should be visible and under no circumstances be concealed under the cloth or under the table.
- (vii) Tap the connecting wires of BU, CU and VVPAT to the leg of the table with "Transparent Adhesive Tape" of half inch width in such a manner that the wires do not hang in the air so that the load of hanging wire does not impact the connecting switch of the BU and VVPAT.
- (viii) Unlock the paper roll knob (vertical position) of VVPAT, before switching ON the CU.



Note:

- The connector of the interconnecting cable, one end of which is attached to the Ballot Unit, is a multi-pin connector. The connector goes into the socket of the other Ballot Unit or of the VVPAT unit only one way, which can be found out easily by looking at the orientation of the pins. The pins of the connector are quite delicate and the connector should not be forced into the socket in such way as may damage or bend the pins. The machine will work only when the connection is made properly. Connect the connectors with proper pin and colour codes.
- The connector of the interconnecting cable can be disconnected from the VVPAT unit or from the other Ballot Unit only by pressing the spring type clips on both sides of the connector hood and pulling the connector out. These spring type clips, when pressed inward simultaneously, will release the hold of the connector from the socket, and the connector should then be pulled out while keeping the spring type clips so pressed.

- Connecting the Ballot Units and the VVPAT or disconnecting them properly requires some practice so as to avoid any damage to the machine. This aspect should be clearly kept in mind and you yourself should connect the Ballot Units with the VVPAT and Control Unit with VVPAT.

3.3. CONDUCT OF MOCK POLL:

- 3.3.1. Mock poll shall be started 90 Minutes before the scheduled hour of commencement of poll. Polling Agents of at least two candidates should be present at the time of Mock Poll.
- 3.3.2. However, if Polling Agents of at least two candidates are not present, the Presiding Officer may wait for 15 more minutes before starting the mock poll and if the agents still do not come, then the Presiding Officer may go ahead and start the mock poll. It is further clarified that after waiting for 15 minutes, there is a possibility that only one Polling agent may be present, in that situation also, the Presiding Officer should go ahead and start mock poll. In such case, there should be specific mention in the **Part-I (Mock Poll Certificate) of Presiding Officer' Report [Annexure-5]** on this aspect.
- 3.3.3. **Ensure the paper roll knob of VVPAT is unlocked (vertical position), before switching ON the CU.**
- 3.3.4 **DEMONSTRATION OF 'CLEARING' OF EVM AND VVPAT BEFORE STARTING MOCK POLL:** Before commencing the mock poll, you have to satisfy not only yourself but also all Polling Agents, who are present at the Polling Station, that the EVM and VVPAT are in perfect working order and that no votes have already been recorded in the machine.

- (i) For such satisfaction, you should first show to all present Polling Agent that all counts have been set to ZERO by pressing the 'Clear' button. The 'Clear' button is provided in a compartment in the Result section of the Control Unit. This compartment is covered by an inner door and an outer cover. The inner door covers the compartments containing 'Clear' button, 'Result' button and 'Print' button and the outer cover is provided above the inner door and covers also the compartment containing the 'Close' button. For reaching the 'Clear' button, you should first open the outer cover by pressing slightly inwards the latch provided on the left side. Thereafter, the inner door can be opened by inserting the thumb and a finger through the two apertures above the 'Result' and 'Print' buttons and then pressing the latches inside simultaneously slightly inwards and pulling the door up. In no case, this inner door should be forced open without releasing the latches in the manner described above as otherwise this most vital compartment will get damaged.
- (ii) When the 'Clear' button is pressed, the Display Panels on the Control Unit will start displaying the following information sequentially:

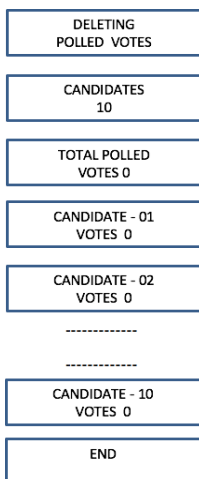

Note:

- (a) If on pressing 'Clear' button, the display panels display INVALID, it means that some of the earlier operations needed for clearing the machine have not been performed. To clear the machine, ensure that Ballot Units, VVPAT and Control Unit have been properly linked. Press 'Close' button and thereafter press 'Result' button. Now press the 'Clear' button, the display panels will start displaying the information as indicated above.
- (b) The display of the above information on the display panels shall satisfy the Polling Agents present at the Polling Station that no votes are already recorded in the machine.
- (c) Polling Agents shall also be allowed to verify that the drop box of VVPAT unit is empty.

3.3.5. PROCEDURE TO BE FOLLOWED TO CONDUCT MOCK POLL:

- (i) One Polling Officer should be present in the Voting Compartment along with the polling agents to watch operations on the Ballot Unit(s) and the ballot slips printed by the VVPAT. This Polling Officer will keep a record of the votes cast.
- (ii) The mock poll should be conducted with the polling agents voting at random for each of the contesting candidates. A total of at least 50 votes should be polled in the mock poll. In the case of absence of polling agents of any of the candidates, one of the Polling Officers or other polling agents may record the votes for such candidates. The Polling Officers present in the Voting Compartment should ensure that votes are recorded for each of the contesting candidates including NOTA. After the mock poll, Presiding Officer will ascertain the result in the CU, tally it with manual records and the VVPAT paper slips in the presence of the polling agents and confirm that the results tally for each candidate.

(iii) **For Mock Poll perform the following operations:**

- Press the 'Ballot' button on the ballot section of the Control Unit. On pressing the 'Ballot' button, 'Busy' lamp in the display section will glow red. Simultaneously, the 'Ready' lamp on the Ballot Unit(s) will also start glowing green.
- Ask any polling agent to press, according to his choice, any of **the candidate's blue buttons on the Ballot Unit. Ensure that** each of the blue (unmasked) buttons is pressed at least once, so that each button left unmasked is tested and found functioning properly.
- On the candidate's button being so pressed, the 'Ready' lamp on the Ballot Unit will go off and the candidate's lamp near the button will start glowing red. The VVPAT will print a small slip of paper that carry the symbol, name and serial number of the candidate voted which will be visible for seven seconds in the VVPAT window. Thereafter, the paper slip will get automatically cut and drop in the drop box of VVPAT. Also, a beep sound will be heard emitting out from the Control Unit. After a few seconds, the red light in the candidate's lamp, red light in the 'Busy' lamp and the beep sound will go off. This will be the indication that the vote for the candidate, whose blue button has been pressed, has been recorded in the Control Unit and the machine is now ready to receive the next vote.
- Repeat the process explained in the above preceding paras for recording one or more votes for each of the remaining candidates. Keep a careful account of the votes so recorded in respect of each candidate.
- When the votes are being so recorded, press the 'Total' button on the ballot section of the Control Unit to verify at any time that the total votes recorded in the machine tally with the number of votes which have been polled up to that stage.

Note: 'Total' button should be pressed only after the vote has been recorded for any candidate and the 'Busy' lamp in the Display Section is off.

- At the end of the mock poll, press the 'Close' button in the result section.

Note: Subject to availability of time, there is no objection to permit the recording of more votes at mock poll. It is not necessary that the number of votes recorded for each candidate should be the same but at least 50 numbers of votes must be cast with one vote for every unmasked button.

- Now press the button marked ‘Result’ in the Result Section. On that button being pressed, the Display Panel will start showing the Result.
- After the mock poll, ascertain the result in Control Unit in the presence of Polling Agents and tally it with the manual record. Remove all mock poll slips from the VVPAT drop box and match it with CU result and confirm that the result tallies with the votes polled in respect of each candidate. The mock poll slips removed from the VVPAT drop box will also include slips of the self-test reports, which are easily identifiable, as the test report slips do not have either the name or the symbol of any candidate. These self-test report slips are to be preserved along with the VVPAT mock poll slips as part of the record, but these should not be counted.
- Next, press the ‘Clear’ button of Control Unit to clear the account of votes recorded during the mock voting. On pressing the ‘Clear’ button, all counts in the Display Panel will show ZERO. Also, the paper slips in VVPAT should be removed from the drop box and the drop box should be sealed with address tag.
- **The Presiding Officers shall ensure that the data of the mock poll is deleted from Control Unit (CU) and mock poll slips have been removed from the VVPAT drop box, without fail, before the actual poll starts. This is a very critical step.**
- Prepare the **Part-I (Mock Poll Certificate) of Presiding Officer’s Report**. The Presiding Officers shall mention the names of the Polling Agents and the candidates (and their party affiliations), whom they represent and also obtain their signatures on the completion of mock poll on the certificate **Part-I (Mock Poll Certificate) of Presiding Officer’s Report (Annexure -5)**. Other Polling Officers shall witness the mock poll process and also certify in the Part-I (Mock Poll Certificate) of Presiding Officer’s Report that mock poll votes erased from the CU and mock poll VVPAT slips removed from the VVPAT before start of actual poll.
- **RECORDING POLL START AND POLL END DATE AND TIME:** The Presiding Officer, at the end of Mock Poll at the Polling Station, shall invariably check and note the date and time shown in the display of the Control Unit and also the actual date and time at that point of time as well as any discrepancy between the two, if any, in the **Part-I (Mock Poll Certificate) of Presiding Officer’s Report (Annexure -5)** and also in Presiding Officer’s Diary (**Annexure -7**).

(iv) **PROCEDURE TO STORE MOCK POLLED VVPAT SLIPS:**

- The mock poll VVPAT paper slips should be stamped on their back side with rubber stamp having inscription “MOCK POLL SLIP”, thereafter these mock poll VVPAT paper slips shall be kept in an envelope made of thick black paper and sealed with the seal of the Presiding Officer.



- The Presiding Officer and Polling Agents must put their signatures on the envelope. The number and name of the Polling Station, number and name of Assembly Constituency, date of poll and the words “VVPAT paper slips of Mock Poll” shall be written on the envelope.

Note: In case of mock poll done during actual poll due to replacement of the EVM-VVPAT set, “VVPAT paper slips pertaining to mock poll conducted in case of replacement of whole set of EVM-VVPAT” shall be written on the envelope.

- The Presiding Officer and Polling Agents must put their signatures on the pink paper seal and keep the black envelop along with other documents relating to elections.

3.4. SEALING OF CONTROL UNIT AND VVPAT AFTER COMPLETION OF MOCK POLL AND BEFORE STARTING ACTUAL POLL

After mock poll and clearing mock poll data, switch off the Control Unit for sealing Result Section of the CU.

3.4.1 Sealing of the Result Section of the Control Unit with Green Paper Seal, Special Tag and Address Tag:

(a) GREEN PAPER SEAL

The modified Green Paper Seal is now provided with self-adhesive stickers at both ends on white side and marked as “A” and “B”. Since the modified Green Paper Seal will have self-adhesion capability, outer paper strip seal will not be required for sealing the control unit.



- There is a frame provided for fixing the paper seal on the inner side of the door of the inner compartment of the result section of the Control Unit. Before the green paper seal is fixed in the frame provided for the purpose on the inner side of the door of the inner compartment of the result section of the Control Unit, you should affix your signature in full immediately below the serial number of the paper seal. It shall also be get signed by such the candidates or their polling agents as are present and are desirous of affixing their signatures. The Presiding Officer should verify that the signatures of the polling agents on the paper seal tally with their signatures on their letters of appointment.



- Insert the Green Paper Seal in the frame provided for it on the inner side of the door of Result Section in such a way that the Green Color Mark on white side

of seal comes on top of the Result button and the Red Color Mark on the top of the Print button. Then close the door in such a manner that the two ends of the paper seal project outwards from the sides of the inner compartment.

- After inserting the Green Paper Seal, the inner door above the result buttons shall be closed. Both Green and Red Color should be visible through the windows of the inner door after it is closed.
- Then, the inner door of the result section shall be sealed with the special tag.

(b) **SPECIAL TAG:** The Special Tag, made of a thick card, is used to seal the inner compartment of the result section of the CU (Control Unit) of the EVM.



Front Side



Back Side

- The metal-ringed hole, near the right upper edge of the Special Tag, is there to make a thread pass easily through it, for the sealing purpose. There is a wide slot in the mid-part of the Special Tag, to allow the “CLOSE” button to be both visible and operable together, once the Special Tag is fixed in the compartment of the result section.
- You must note down the serial number of the CU upon the Special Tag, before it is used for the sealing purpose.
- You must sign on the BACK of the Special Tag after noting down the Serial Number of the CU on its FRONT. You must advise the contesting candidates/ Polling Agents, present inside the Polling Station, to sign on the BACK of the Special Tag, if they feel like it. You must both read out the pre-printed serial number on the Special Tag, and ask the contesting candidates/ Polling Agents, to note it down for their reference later.
- The inner door of result section should be sealed with the Special Tag. To achieve this, you must pass the high-quality thread (supplied by the Returning Officer) through the holes provided in the inner door and through the metal ringed hole provided in the Special Tag.
- Under no circumstance, should a spoiled or torn Special Tag be used. Use another one in such a case. Like the extra “Green Paper Seals”, you are supplied with 2 or 3 extra Special Tags also.
- Once the aforementioned process is completed, you must tie the thread into a knot, and thereafter fix the thread on the Special Tag by using the sealing wax. Subsequently, taking care that the seal is not broken, you may adjust the Special Tag in the compartment of the “CLOSE” button in a manner that the “CLOSE” button projects through the hole in the mid-part of the Special Tag.

- After fixing the Special Tag, close the outer door of the Result Section ensuring that the loose ends of the Green Paper Seal protrude out from both the sides of the closed outer door. Then the Presiding Officer shall seal the outer door with thread and address tag.
- The wax paper from 'A' side of the Modified Green Paper Seal should be removed and the 'A' side shall be pasted on the outer door of the Result Section.
- The wax paper from 'B' side of the Modified Green Paper Seal should be removed and the 'B' side shall be pasted on top of the underlying 'A' side of the Modified Green Paper seal in such a way that the serial no. of the seal is visible on the top.

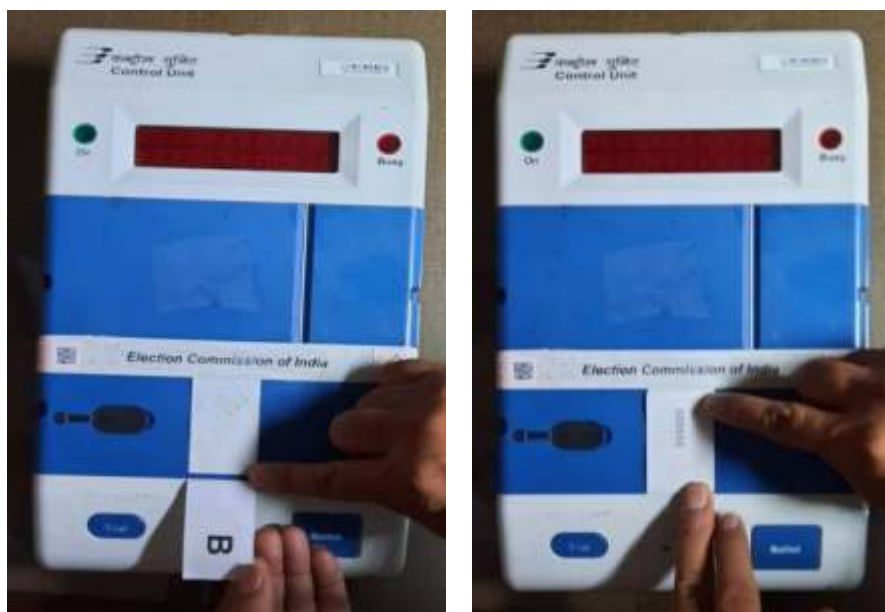

(c) Sealing of drop box of VVPAT with thread using Address Tag

The lower part of the VVPAT unit, i.e., the Drop Box, is sealed with the thread and the Address Tag before the actual poll commences. Ensure to remove all mock poll slips from the Drop Box before sealing it.



3.4.2. EVM AND VVPAT READY FOR ACTUAL POLL: The EVM and VVPAT combination is now ready in every respect, to be used for the actual poll.

3.4.3. MOCK POLL IN CASE OF REPLACEMENT OF EVM

- In case the CU or BU or VVPAT does not work properly during **mock poll**, replace the respective unit only.
- In case the CU or the BU does not work properly **during actual** poll, replace entire set of CU, BU and VVPAT. In such case cast only one vote to each contesting

candidate including NOTA in the Mock Poll and follow instructions of mock poll as mentioned above in para 3.3.5.

- In case the VVPAT does not work properly **during actual poll**, replace only VVPAT. NO MOCK POLL is required in case of replacement of VVPAT only.

3.4.4. CRITICAL MISTAKES

- Not pressing the CLOSE button of CU after mock-poll.
- Not matching the mock-poll result of the CU with the VVPAT Paper Slips.
- Not removing the mock-poll paper slips from VVPAT.
- Non-deletion of mock-poll data from the Control Unit.
- Positioning the VVPAT under direct light falling on it.
- Positioning the VVPAT near an open window.

Note:

- The Presiding Officer should show the Machine Numbers to the agents present before the commencement of the mock Poll.
- The Presiding Officer should note the number and Serial Number of CU, BU and VVPAT used at the Polling Station in his/her Diary.

3.4.5. ACCOUNT OF PAPER SEALS

- You should keep a correct account of the green paper seals supplied to you for use at the Polling Station and the green paper seals actually used by you for sealing and securing the Control Unit. Such account shall be maintained by you in the form specifically prescribed for the purpose vide Item 10 of Part I of Form 17C (**Annexure – 8**) appended to the Conduct of Elections Rules, 1961.
- You should allow the candidates, or their Polling Agents present to note down the serial number of green paper seals so supplied for use and actually used.

3.5. DON'S WHILE HANDLING ELECTRONIC VOTING MACHINE (EVM) AND VOTER VERIFIABLE PAPER AUDIT TRAIL (VVPAT)

(Relevant for PrO & Team)

DURING DISPERSAL TO Polling StationS	
1	Don' forget to ensure EVM/VVPAT is related to the particular Polling Station for which it has been allotted.
2	Don' take away any EVM & VVPAT to any unauthorized place like residence, etc.
3	Don' repeatedly switch ON and OFF the VVPAT as it will deplete the battery as well as paper roll causing problems during the poll day.
4	Don' forget to switch OFF the CU while connecting or disconnecting the EVM units and VVPAT using cables
5	Don' pull the cable of BU & VVPAT while disconnecting from the CU.
7	Don' switch on the VVPAT at the time of dispersal.
8	Don' connect Ballot Unit, Control Unit and VVPAT during dispersal
9	Don' keep VVPAT knob vertical (Working mode) while transporting.
10	Don' stay at any place other than designated place.

11	Don't remove any seal from BU, CU and VVPAT.
12	Don't use vehicle other than vehicle provided for dispersal.
DURING MOCK POLL	
1	Don't start mock poll, if no or one election agent is present. Wait for 15 minutes.
2	Don't stop mock poll without casting at least 50 votes.
3	Don't keep BU, CU and VVPAT on one table for mock poll. (Keep BU & VVPAT at voting compartment)
4	Don't forget to cast at least one vote to each candidate button including NOTA during mock poll
5	Don't leave any mock poll slips inside the VVPAT slips compartment after completion of mock poll on poll day.
6	Don't forget to delete mock poll data from the CU before starting of actual poll.
7	Don't keep mock poll VVPAT slips unstamped in black envelope.
8	Don't forget to tally EVM count with VVPAT slips count during mock poll.
9	Don't forget to fill Mock Poll Certificate (Part-I of Presiding Officer Report)
10	Don't start actual poll without sealing Result Section of CU and Drop Box of VVPAT and taking signatures of polling agents.
DURING POLL	
1	Don't operate the paper roll knob till the end of the poll.
2	Don't forget pressing of close button of CU after completion of poll.
3	Don't conduct mock poll in case of replacement of only VVPAT during the actual poll.
4	Don't hang any high illumination bulb over VVPAT at Voting Compartment
5	Don't Switch ON the Control Unit at the time of connection and disconnection of Ballot Unit, Control Unit and VVPAT
6	Don't Switch ON Control Unit when VVPAT paper roll knob is in lock position (horizontal position)
7	Don't forget to tape the interconnecting cable of BU/VVPAT to the leg of the table with 'transparent' adhesive tape.
8	Don't forget to press both side latches of connector while disconnecting the cable
9	Don't forget to clear mock poll data from the Control Unit and VVPAT mock slips from VVPAT in mock poll process
10	Don't enter into the voting compartment to educate illiterate how to cast vote. Use cardboard BU for this purpose.
11	Don't Switch OFF/Switch ON EVM during poll process
12	Don't forget to remove VVPAT Power Pack (Battery) from VVPAT before sealing of VVPAT in its carrying case after completion of poll

3.6. Poll Day Instructions on EVM/VVPAT to Polling Parties

1. Connecting CU, BU, VVPAT M3

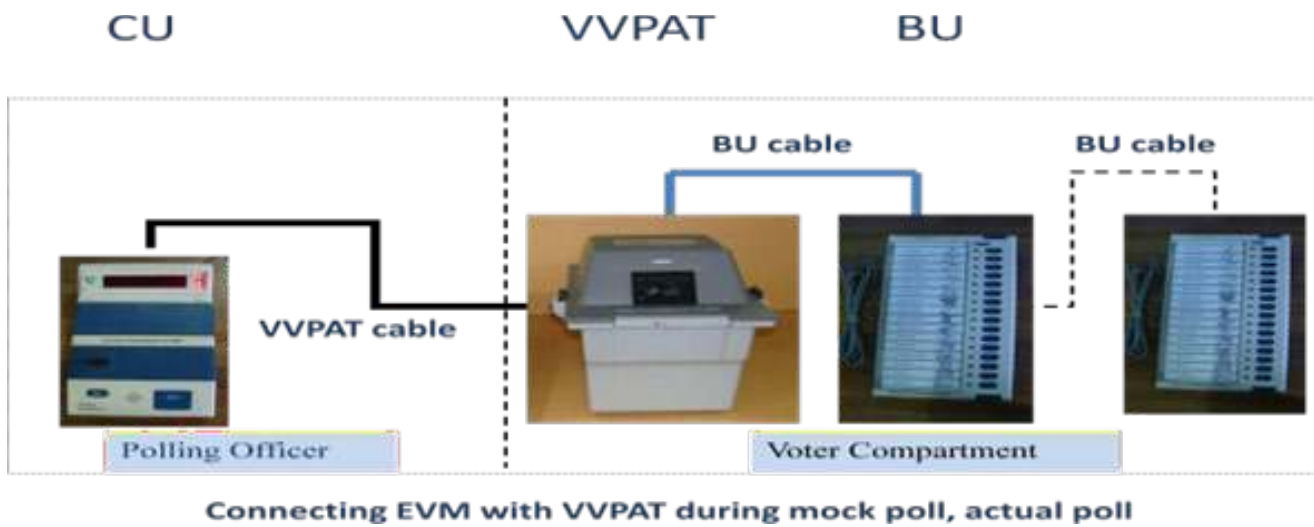

2. Conduct of Mock Poll and Verification

- At least 50 votes should be cast during Mock Poll in the presence of Candidates/Agents.
- After the Mock Poll is completed, Press the CLOSE button on CU.
- Press the RESULT button on CU and manually record the data displayed by CU.
- Press the CLEAR button on CU and observe TOTAL should be Zero in CU. Switch OFF the CU.
- Open the ballot compartment door of the VVPAT and collect the VVPAT ballot slips
- Segregate these ballot slips as per the party symbol and record the result of the counted slips. Keep aside the POST slips.
- Compare the VVPAT result data with the CU result data. Both must tally candidate wise.
- Fill mock poll certificate carefully and correctly.

3. Sealing of CU and ballot slips compartment of VVPAT after Mock Poll

- After the mock poll, the VVPAT paper slips should be removed and stamped on their back side with rubber stamp having inscription "MOCK POLL SLIP", thereafter these mock poll VVPAT paper slips shall be kept in an envelope made of thick black paper and sealed.
- This envelope must be sealed with pink paper seal in such manner that opening of the envelope will require breaking of the seal.
- Fix Green Paper Seal in the inner Result Section on CU, Special Tag in the Close Button on CU.
- Ensure that the ballot compartment of VVPAT is empty before actual poll and the ballot slips compartment is sealed with the thread and address tags before actual poll starts.

4. Replacement of EVM-VVPAT from Preparation to Mock poll

- ▶ In case BU does not work properly, replace **BU ONLY** from reserve BU.
- ▶ In case CU does not work properly, replace **CU ONLY** from reserve CU.
- ▶ In case VVPAT does not work properly, replace **VVPAT ONLY** from reserve VVPAT.

5. Replacement of EVM-VVPAT during Actual Poll

- ▶ In case CU or BU does not work properly replace complete set of BU, CU & VVPAT. **In such case only one vote to each contesting candidate including NOTA should be polled in mock poll and procedure followed.**
 - If CU display change VVPAT, replace only VVPAT. In that case no mock poll is required to be conducted.
 - If CU display change Power Pack of CU or VVPAT, replace only Power Pack of CU or VVPAT

3.7. Replacement of EVM/VVPAT during or before Actual Poll

REPLACEMENT OF EVM-VVPAT

During Actual Poll	BU Defective	Replace Complete Set of BU, CU & VVPAT	<ul style="list-style-type: none"> ➤ Mock poll by casting 1 vote to each unmasked button ➤ Remove VVPAT battery, Seal defective units in carrying cases ➤ Prepare PrO Report Part-I & Part-V
	CU Defective		
	CU Battery Defective	Replace CU Battery Only	<ul style="list-style-type: none"> ➤ No mock poll ➤ Prepare PrO Report Part-II
	VVPAT Defective	Replace VVPAT Only	<ul style="list-style-type: none"> ➤ No mock poll ➤ Remove VVPAT battery, Seal Defective VVPAT in carrying case ➤ Prepare PrO Report Part-V
	VVPAT Battery Defective	Replace VVPAT Battery Only	<ul style="list-style-type: none"> ➤ No Mock Poll
Before Actual Poll	Any Defect	Replace Defective Unit(s) Only	<ul style="list-style-type: none"> ➤ Continue Mock Poll with New Unit(s) ➤ Prepare PrO Report Part-I and IV ➤ Return defective unit(s) to SO



- ❖ DO NOT OPEN sealed VVPAT drop-box in any case
- ❖ Always SWITCH-OFF CU before any connection or disconnection
- ❖ Always connect by matching red-black color code
- ❖ Put VVPAT switch in UNLOCK position before switching-on CU

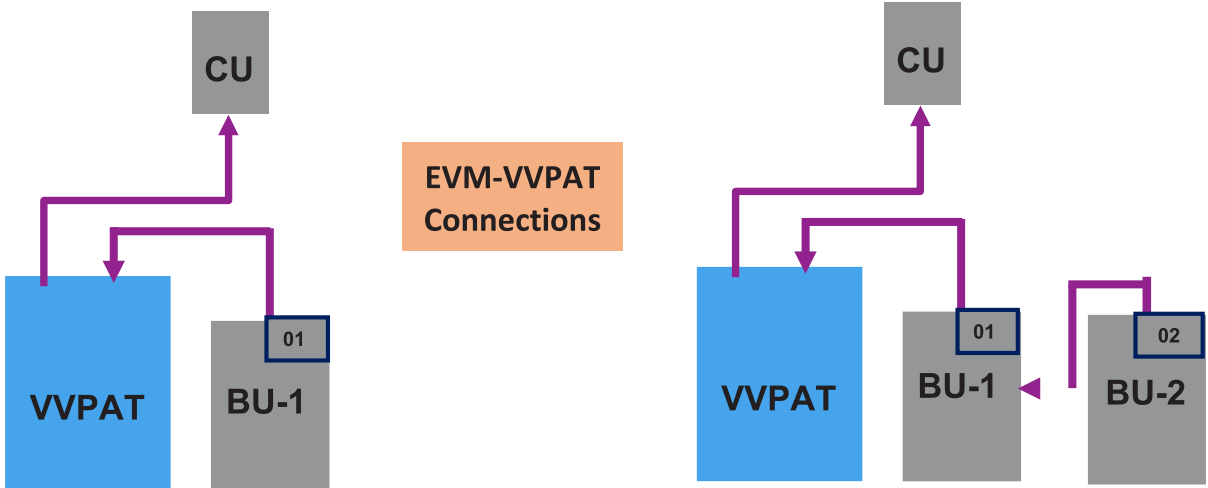

CHAPTER – 04

POLLING PROCEDURE

4.1 ENFORCEMENT OF ELECTION LAW IN AND AROUND POLLING STATION

(i) IMPARTIALITY AND MAINTENANCE OF DECORUM

You must treat all political parties and contesting candidates (including the independent candidates) on an equal footing. You must decide any point of dispute that arises in a fair and just manner. Your impartiality, firmness and tact in all the matters, will stand you in good stead, and shall contribute to the conduct of free and fair election at your Polling Station. You must not show any familiarity with any contesting candidate, polling agent, celebrity, VIP or elector (applies to PO1, PO2, PO3 also); though normal courtesy may be shown. Treating politely each elector, is part of your duty.

(ii) BAN ON CANVASSING

Canvassing within 100 m (one hundred metres) of the Polling Station is an electoral offence. Any person who indulges in such an activity, may be arrested without warrant, and may further be prosecuted under Section 130 of the Representation of the People Act, 1951 (**Annexure -1**).

(iii) CANDIDATE ELECTION BOOTH

Contesting Candidates are allowed to put up their election booths, beyond a distance of 200 metres from the Polling Station with one table and two chairs and an umbrella or a piece of tarpaulin over their head to protect them from sun/rain. Such election booths should not be allowed to be crowded. You must bring to the notice any case of violation of the aforementioned by immediately calling your Sector officer (or any other official/officer responsible to maintain law and order at your Polling Station), the aforementioned must be done to ensure that the necessary remedial action is taken timely, in order to ensure the peaceful conduct of polls.

(iv) DISORDERLY CONDUCT IN OR NEAR THE POLLING STATION

If a person is found to behave in a disorderly manner (including the use of sound- amplifiers, e.g., loudspeaker, megaphone etc.) in the Polling Station premises (inside or near the Polling Station), you can have him arrested by the police then and there, and also prosecuted later on (**Section 131 of the Representation of the People Act, 1951 – Annexure 1**). But you must use this power only as the last resort, after gentle persuasion and strict warning produce no effect on the person concerned.

(v) REMOVAL OF TROUBLEMAKERS

A person misbehaving or not obeying your directions (in light of the law in force) in course of the poll, may be removed from the Polling Station with the help of the police or persons authorised by you for the purpose (**Section 132 of the Representation of the People Act, 1951- Annexure 1**).

(vi) ILLEGAL HIRING OF VEHICLES FOR THE CONVEYANCE OF VOTERS

If you are informed by a complainant about the conveyance of electors from their homes to the Polling Station by use of a means of transport on behalf of a contesting candidate, you must forward this complaint to the concerned Sub-Divisional Magistrate through your Zonal/ Sector Magistrate.

(vii) REMOVAL OF VOTING MACHINE AND/OR OTHER POLLING MATERIALS FROM Polling Station TO BE AN OFFENCE

- Any person, who at any election fraudulently or in an unauthorized way takes or attempts to take a voting machine out of a Polling Station or wilfully aids or abets the doing of any such act, commits a cognizable offence punishable with imprisonment up to one year or with fine up to five hundred rupees or with both. In this connection Section 135 of the Representation of the People Act, 1951 read with Explanation to Section 61A of the said Act may be referred to.

- In case of polling material other than the EVM is taken out or attempted to be taken out, the action is an offence under Section 135-A of Representation of People Act 1951.
- In above circumstance or incident, you should handover him/her to the local Police Station having jurisdiction over the Polling Station with written information to the concerned Police Station in-charge.

(viii) BREACH OF OFFICIAL DUTY BY ELECTION OFFICERS

Your attention is also drawn to Section 134 of the Representation of the People Act, 1951, which provides that if any Presiding or Polling Officer is guilty of any act, or even of any omission, in breach of his official duty without reasonable cause, he commits a cognizable offence.

(ix) PROHIBITION OF GOING ARMED TO OR NEAR A POLLING STATION

As per the provisions of Section 134B of the Representation of the People Act, 1951, no person (other than the Returning Officer, the Presiding Officer, any police officer and any other person appointed to maintain peace and order at a Polling Station who is on duty at the Polling Station) can, on a polling day, go armed with arms, as defined in the Arms Act, 1959, of any kind within the neighbourhood of a Polling Station. If any person violates these provisions, he is liable to imprisonment for a term, which may extend to two years or with fine, or with both. The offence is cognizable.

(x) PROHIBITION OF USE OF CELLULAR PHONES, CORDLESS PHONES, WIRELESS SETS ETC

No cell phone, smart watch, cordless phone, wireless set etc., is allowed inside the Polling Station, including inside the 100-metre perimeter of the Polling Station (defined by the ECI as the “Polling Station neighbourhood”). Presiding Officer is permitted to carry his/her mobile phone in silent mode and Micro – Observer if posted in a Polling Station can also carry his/her mobile phone in silent mode. In case of shadow area, wireless set or satellite phone may be permitted to be used by PrO.

4.2. COMMENCEMENT OF THE POLL

(i) COMMENCEMENT OF POLL AT THE SCHEDULED TIME

The poll must commence at the scheduled time (precise hour and minutes) separately intimated about. Every prescribed preparation must be completed before the commencement of the poll (refer the PrO Checklist). If the poll does not commence as per the schedule, you must note down the reasons for the delay in the Presiding Officer’s Diary (PrO Diary) [Annexure - 7]. Ensure to clear the mock poll result from the EVM. Ensure to remove the paper slips of the mock poll from the VVPAT Drop Box. Inform the Returning Officer promptly about the commencement of the poll through Sector Officer.

(ii) FOREWARNING ABOUT ‘SECRECY OF VOTING’

You must elaborate to the contesting candidate/ Polling Agents, (present inside the Polling Station), about their being legally duty-bound to maintain the ‘secrecy of voting’ and the penal provisions in case of violation thereof {As per Section 128 of the Representation of the People Act 1951 (Annexure –1)}.

(iii) DECLARATIONS BY PRESIDING OFFICER.

You must read out the ‘Declaration by the PrO’ (prescribed in the Part I of Annexure – 6), prior to the commencement of the poll. You must read out the declaration aloud to the persons present inside the Polling Station; sign the declaration yourself; and obtain the signatures thereon of the contesting candidates/ Polling Agents present. The name of any polling agent declining to sign on the declaration, must be noted thereupon itself. This is to ensure that you have carried out the instructions regarding the demonstration of the EVM-VVPAT, marked copy of the electoral roll, the Register of Voters, and obtained the signatures of the contesting candidates/ Polling Agents on the green paper seal, and allowed them to note down their serial numbers. These are necessary safeguards for

ensuring free and fair election. This must be done immediately after reading out the provisions of Section 128 of the Representation of the People Act, 1951, regarding the maintenance of secrecy of voting.





(iv) PRECAUTIONS REGARDING INDELIBLE INK

You must advise the PO2 (Polling Officer In-Charge of the Indelible Ink) to undertake adequate precautions for the poll duration, to ensure that the phial containing the indelible ink is placed carefully inside the container (provided for the purpose) in such a manner that the container does not get tilted to spill the ink. Loose earth should be filled around the phial in the remaining space inside the container (a flat-bottomed tin container), in a manner that the phial is firmly fixed lengthwise three-fourth (75%) vertically down into the centre of the container. The brush, supplied with the ink, protruding from the cork-lid of the phial (provided for applying the indelible ink) should always be kept dipped vertically downward from the mouth of the phial, except for lifting it out for the purpose of marking the voter’s index finger.

(v) MARKED COPY OF THE ELECTORAL ROLL (‘MARKED VOTER LIST’ OR ELECTORAL ROLL FOR POLL PURPOSE)

Prior to the commencement of actual poll, you must exhibit to the contesting candidates/ Polling Agents, present inside the Polling Station, that the marked voter list (i.e., the one to be used for ‘marking’ names of the electors for voting purpose), does not contain remarks other than those used for issuing the postal ballots including absentee voters category and the Election Duty Certificates (EDC). Electoral Roll as it exists on the final date of publication plus the additions (if any) as made by the last date of nominations, constitutes a single integrated entity, to be utilised for the actual poll-conduct purpose. The additions made to the electoral roll, during the summary revision, must reflect in the chronological order, by allotting the newly added electors serial numbers in continuation of the preceding last serial number (i.e, the last entry of an elector in the final roll). No separate list for addition, deletion and modification is to be printed (in compliance of Ref to latest instruction in this matter). All the entries which have been modified/ corrected on the basis of Form-8, during the period of revision/continuous updation, will be reflected in the integrated roll itself replacing the existing entries, with the sign of # (in case of corrections were made during summary revision) or ## (in case of corrections were made during continuous updation period), as the case may be to indicate that the entry has been modified and replaced. An image of dummy marked copy of Electoral Roll is shown below:

Dummy Marked Copy of Electrol Roll

<p>Sr. No. 18 RJ/12/094/909297</p> <p>Name: AB Father Name: DELETED House No.: 3/10 Age: 42 Sex: M</p> 	<p>Sr. No. 19 RJ/32/194/239276</p> <p>Name: DF Husband Name: RT House No.: 3/11 Age: 21 Sex: F</p> 
<p>Sr. No. 20 UCW1075683</p> <p>Name: EW Father Name: JU House No.: 4/01 Age: 19 Sex: M</p> 	<p>Sr. No. 21 UCW0389675</p> <p>Name: TY Father Name: FH House No.: 305 Age: 83 Sex: M</p> 

You must also exhibit the ‘Register of Voters’ (Form 17A), (to make entries in respect of the electors) to the contesting candidates/ Polling Agents, present at the Polling Station, to let them ascertain that it does not already contain any entry in respect of any elector.

(vi) **REGULATION OF ENTRY OF VOTERS TO POLLING STATION**

You must ensure three separate queues for PwD/senior citizens, male and female electors. You must instruct the official (Police Constable/Home Guard/any authorised Election Official) administering the queues, to permit three to four electors inside the Polling Station at a time. The remaining electors shall wait for their turn in the queue outside. For entry of one male elector, two female electors may be allowed entry into the Polling Station. Under no circumstance, you must allow more than one queue each for men and women electors. The PwD electors, physically infirm electors, pregnant women electors, women electors bearing babies in their arms and Senior Citizens, should be given priority in voting ahead of the other voters in the queue. They should not be made to wait in the queue with the other electors. All the ECI prescribed facilitation (instructions separately issued) must be provided to them at the Polling Station. If warranted, a separate queue for such persons may be formed. You must ensure that such electors may take their wheel-chair inside the Polling Station. If a permanent ramp is lacking in your Polling Station, a temporary ramp made of wood, may be arranged for. You must give special care to the PwD electors suffering from speech and hearing impairment.

4.3. VERIFICATION OF ELECTOR’S IDENTITY AND PROCEDURE IN CASE OF CHALLENGE

4.3.1 VERIFICATION OF ELECTOR’S IDENTITY

- The Commission has made documentary identification of electors as mandatory. The electors are required to produce the Electoral Photo Identity Card (EPIC) or other alternative document if any, permitted by the Commission. The Commission will issue orders in this regard at the time of every election. You must refer to the order issued by the Commission and enforce its compliance. The Polling Officer in-charge of identification must satisfy himself about the identity of the elector after examining the EPIC or the alternative documents, as the case may be, and in case of any doubt the elector should be directed to present himself before you. You should make a further probe to satisfy yourself about the identity of the elector. You should hand over the person to the police with a written complaint in case he is proved to be an impersonator.
- In order to prevent impersonation at the time of poll, the Commission has directed the following procedure:

(a) For ASD voters -

- List of ASD voters should be prepared Polling Station wise and it should be ensured that each Presiding Officer should be provided with a separate list of Absentee, Shifted and Dead electors, having following format:

Annexure-13A

Format of ASD List

Assembly Constituency Number and Part:

Polling Station Part and Name: -

Sl. No.	Elector’s Serial No. in Electoral roll	Elector’s Name	Father/Husband/Mother’s Name	Age	Absent, Shift or Dead means A,S or D as applicable write the same
1	2	3	4	5	6

Signature BLO

Full Name

Signature Returning Officer

Stamp

- On the day of poll, in order to cast one’s vote, the elector, who is in such list, shall have to produce EPIC for his identification or any one of the alternative photo documents, if permitted by the Commission. The Presiding Officer shall verify the identification document personally and the details properly registered by the Polling Officer concerned in the Register of Voters in Form 17A.

- The First Polling Officer shall inform the Polling Agents about the ASD elector who has come to vote by reading out his/her name loudly. Thumb impression of such electors shall also be obtained in addition to signature against the column of “signature/thumb impression” of Register of Voters (Form 17A). The thumb impression shall be in addition to the signature even in the case of an elector who is a literate and can sign.
- A declaration shall also be obtained from the ASD electors in the format at **Annexure – 14**.
- Presiding Officer shall maintain a record and give a certificate at the end of the poll (to be kept with Form 17A for scrutiny) that so many electors from the list of absentees and shifted electors were allowed to vote after proper scrutiny.
- If videography/photography is being done in the Polling Station, such electors shall be photographed/videographed and their record kept.
- Presiding Officer should comply with these instructions meticulously. Micro-observer, where deployed, should also observe and make a mention about this in their report.
- The Presiding Officer shall be briefed specially about these procedures to be followed in Polling Stations for electors who are in the list of Absentee, Shifted and Dead electors.

(b) For Overseas Electors:

- The Election Commission has directed that identification of overseas electors at the time of casting of votes at Polling Station shall be done only on the basis of original passports produced by them.
- As has already been explained in Chapter-2, an elector on entering the Polling Station will proceed directly to the first Polling Officer, who will be in-charge of the marked copy of the electoral roll and responsible for identification of electors. The Polling Officer should properly verify Voter’s identity as explained above. It should be noted that carrying of unofficial identity slip by an elector does not guarantee the identity of the voter nor does it absolve the Polling Officer of his duty and responsibility of satisfying himself about the identity of such voter.
- Further, even if a person comes with EPIC, but if his/her name is not included in the Electoral Roll, he/she can not vote.
- Political parties/candidates may also have given unofficial identity slips to the electors. As per Commission’s instructions, such slip should be on a plain white paper and may contain the name of the elector, his serial number in the electoral roll, part number of the electoral roll and the number and name of the Polling Station where he is to cast his vote. The slip should not contain the name of the contesting candidate and/or the name of the party and/or the facsimile of symbol allotted to him (as that would amount to campaigning). If you come across any such slip, which has been issued by a contesting candidate or his party in violation of these instructions of the Commission and has been brought to the Polling Station by any elector, you should bring it to the notice of the polling agent of the candidate concerned forthwith for putting an immediate end to such violation. Note that the slip supplied by the political parties/candidates is not an approved document of identity of elector.
- In case there are large number of women electors especially ‘pardanashin’ (burqa clad) women, a woman Polling Officer may be appointed for identification of such woman voters in a separate enclosure as instructed in **para 2.6.(i)**

4.3.2. ABSENTEE VOTERS WHO HAVE BEEN ISSUED POSTAL BALLOT

The Absentee Voters who have been issued Postal Ballots are marked in the Marked Electoral Roll as Absentee Voter Essential Service (AVES), Absentee Voter Senior Citizen (AVSC), Absentee Voter Persons with Disability (AVPD), Absentee Voter Covid (AVCO) shall not be allowed to cast their vote in the Polling Station. Even if the voter requests that though he/she has been issued with postal ballot, and could not cast his/her vote and hence be allowed to cast his/her vote at the Polling Station, such request shall not be accepted, and they shall not be allowed to cast the vote at the Polling Station.

4.3.3. LIST OF DEAD, ABSENT AND ALLEGED BOGUS VOTERS

Polling agents may bring with them a copy of the list of the names of dead, absent and allegedly bogus voters. Also, you have received among the other polling material the ASD list supplied by the Returning Officer. If any person claims to be an elector, Follow ASD voters identification steps mentioned in para 4.3.1 above.

4.3.4. CLERICAL AND PRINTING ERRORS IN THE ROLL TO BE OVERLOOKED

The particulars in respect of an elector as entered in the electoral roll are sometimes incorrectly printed or have become out of date e.g., regarding the exact age of the voter. You should overlook mere clerical and printing errors in any entry relating to an elector in the poll, provided that you are otherwise satisfied about the identity of the person claiming to be the elector, according to other particulars entered in electoral roll. When the electoral roll has been prepared in more than one language and the name of a person has not been included in the marked copy of the electoral roll, such a person should be allowed to vote if his name appears in the version of the electoral roll in the other language for the same area. An entry in respect of every such elector should be noted by you in ink on the marked copy of the electoral roll.

4.3.5. FACT OF ENROLMENT OF A VOTER NOT TO BE QUESTIONED

So long as the identity of a voter is established to your satisfaction, he has the right to vote. No question can be raised at the Polling Station about the eligibility of such a person to be a voter. For instance, you are not entitled to hold any inquiry into the question whether he is over 18 years of age or ordinarily resides in the constituency. But in the case of a person whom you consider much below the qualifying age, you must follow steps mentioned in **Chapter - 5**.

4.4 APPLICATION OF INDELIBLE INK AND OBTAINING SIGNATURE/ THUMB IMPRESSION OF ELECTOR BEFORE PERMITTING HIM TO RECORD HIS VOTE

4.4.1. INSPECTION OF VOTER'S LEFT INDEX FINGER AND APPLICATION OF INDELIBLE INK

- (i) As soon as may be, after the identity of an elector has been verified by the first Polling Officer, and if there is no challenge as to the elector's identity, his left-hand index finger will be inspected by the second Polling Officer for any indelible ink mark thereon. If no mark is seen on the finger, the second Polling Officer shall mark the elector's left-hand index finger with indelible ink in the manner described in **para 1.10 of Chapter – 1** in such a way that a clear mark is left. If any elector refuses to allow his left index finger to be inspected or marked in accordance with the instruction or has already such a mark on his left index finger or does any act with a view to removing the ink mark, he shall not be allowed to vote.



- (ii) In case it is noticed that an elector has applied any oily or greasy substance on his finger in order to neutralize the indelible ink mark to be put on his finger, such oily or greasy substance should be removed by the Polling Officer with the help of a piece of cloth or rug before putting indelible ink mark on the finger of that elector. Piece of cloth or rug will be supplied in the Presiding Officer's kit.
- (iii) Marking of the indelible ink is required to be made before obtaining the signature/thumb impression of the elector in the Register of Voters in Form 17A, so that by the time the elector leaves the Polling Station after casting his vote, there is sufficient time gap for the indelible ink to dry up and develop a distinct indelible mark on the left-hand index finger.

4.4.2 APPLICATION OF INDELIBLE INK AT FRESH POLL (RE-POLL)/ COUNTERMANDED POLL

- (i) It is clarified that at the time of fresh poll (re-poll)/countermanded poll, the marking with indelible ink made during original poll should be ignored and fresh marking with indelible ink should be put on the voter's left-hand middle finger in such a way that a clear mark is left.
- (ii) Under rule 49K of the Conduct of Elections Rules, 1961 every elector about whose identity the Presiding Officer or the Polling Officer, as the case may be, is satisfied, shall allow his left index finger to be inspected by the Presiding Officer or Polling Officer and an Indelible Ink mark to be put on it. Some States/UTs have sought clarification from time to time on application of Indelible Ink on such voters on whom Indelible Ink is already marked during previous elections on left hand index finger and impression of the ink is still visible on poll day. In this regard it is stated that after the application of the ink on finger the stain remains for 5-7 days on skin part but stain remains visible on nail till nail grows. The Commission has considered the matter and directed that:
 - If any poll has been conducted not more than two months prior to the date of poll of current election, in such cases, the Indelible Ink shall be marked on the middle finger instead of index finger of the left hand. If ink has already been applied on index finger as well as middle finger, then the ink shall be applied on ring finger and so on.
 - In case of missing finger rule 49K of the CER, 1961 shall continue to apply.

4.4.3 APPLICATION OF INDELIBLE INK WHEN ELECTOR HAS NO LEFT INDEX FINGER

It is clarified that if an elector has no left-hand index finger, then indelible ink should be applied on any such finger which he has on his left hand. Further, if he does not have any fingers on his left hand, the ink should be applied on his right-hand index finger and if he has no right-hand index finger, on any other finger which he has on his right hand starting with his index finger. If he has no fingers on either hand, ink should be applied on such extremity (stump) of his left or right hand as he possesses.

4.4.4 RECORD OF ELECTORAL ROLL AND NUMBER OF ELECTORS IN REGISTER OF VOTERS

- (i) After the left-hand index finger of the elector has been marked first time by the second Polling Officer in the manner explained in the preceding paragraph, he should maintain the record of such elector in the 'Register of Voters' (Form 17A) and obtain the signature/thumb-impression of the elector on that register.
- (ii) Such record shall be maintained by the second Polling Officer in the Register of Voters in the following manner:
 - (a) In column (1) of the Register of Voters, the second Polling Officer will write down the serial numbers of electors in consecutive order, starting with serial number 1. (Generally, the serial numbers of electors in consecutive

order are already printed in the register.) Each page of the register contains 10 serial numbers. If the serial numbers are not already printed in column (1), he can write such serial numbers manually in advance on a few pages at the commencement of poll.

- (b) In column (2) of the said register, the second Polling Officer will write down the electoral roll number (i.e. the serial number) of the elector as entered in the marked copy of the electoral roll. For example, if the name of the first elector who comes to vote at the Polling Station at the commencement of poll is entered at serial number 756 in the marked copy of the electoral roll, the Second Polling Officer will write down serial number 756 in the second column against serial No. 1 in the first column of the Register of Voters. Likewise, if the second voter's name is entered at serial number 138 in the electoral roll, the second Polling Officer will write serial number 138 in column (2) against serial number 2 in column (1) of the register, and so on
- (c) In column (3) of Form 17A (Register of Voters), the last four digits of the identification document should be mentioned. In the case of electors voting on the basis of the EPIC, it is sufficient that the letters 'EP' (denoting EPIC) is mentioned in the relevant column, and it is not necessary to write down the number of the EPIC. However, in the case of those who vote on the basis of any alternative documents, the instructions to note down the last four digits of the document shall continue to apply. The type of the document produced should also be mentioned therein.
- (d) After columns (1), (2) and (3) of the register have been filled in respect of an elector in the manner described above, his signature/thumb impression shall be obtained by the second Polling Officer in column (4) of that register.

4.4.5 DEFINITION OF SIGNATURE OF ELECTOR

A signature may be described as the writing of a person's name on a document with the intention of authenticating that document. A literate person, while signing on the Register of Voters, will be required to write his name, i.e. both his name or names and his surnames in full or in any case his surname in full or names either in full or by means of initials of that name or names. If a literate person puts simply a mark and insists that, that mark should be taken as a signature, while claiming to be a literate person, then, that mark can not be taken to be his signature because as stated above, signature means, in the case of a literate person, the writing of the name of that person by himself in authentication of a document on which he writes his name. In such a case, if he refuses to sign his name in full as indicated above, then his thumb impression should be taken. If he refuses to give his thumb impression also, then he should not be allowed to vote.

4.4.6 THUMB IMPRESSION OF ELECTOR

- (i) If an elector is unable to sign his name, the impression of his left-hand thumb should be obtained on the Register of Voters. It should be noted that it is not necessary for you or any Polling Officer to attest such thumb impression on the register.
- (ii) In conformity with Rule 37(4) of the Conduct of Elections Rules, 1961 regarding application of indelible ink, if the left-hand thumb of the elector is missing, then the impression of right-hand thumb should be taken. If thumbs on both hands are missing, the impression of one of the fingers of the left hand starting from the index finger should be taken. If there are no fingers on the left hand, the impression of the fingers of the right hand should be taken. If no fingers are available, the voter will naturally be unable to record his vote himself and will, therefore, necessarily have to seek assistance of a companion under rule 49N of the said rules. In that case, the signature or thumb impression of the companion should be taken on the Register of Voters and remark to that effect should be made in column (5) of the Register of Voters.

- (iii) It is necessary that the thumb impression on the Register of Voters should be a clear thumb impression. The thumb of the voter should not be inked so lightly from the stamping pad that it gives only a faint or undecipherable impression. Nor should the thumb be inked so heavily that it gives a smudged impression instead of a clear thumb impression on the register.

4.4.7 SIGNATURE/THUMB IMPRESSION ON THE ‘REGISTER OF VOTERS’ BY BLIND OR INFIRM ELECTORS

Thumb impression of a blind or infirm elector or a voter suffering from leprosy, which are illiterate but can use their hands, should be obtained on the Register of Voters. In case any such voter is literate, he may be allowed to put his signature in place of thumb impression. In case of infirm voter, who can not use either of his hands, his companion shall put his signature or thumb impression on the register. A note may be made against such entry in the register that signature or thumb impression is that of the companion. After taking the thumb impression, the ink on the elector’s thumb should be wiped off with the help of wet piece of cloth.

4.4.8 ISSUE OF VOTER’ SLIP TO ELECTOR

- (i) After an elector’s left-hand index finger has been marked with indelible ink, the entry relating to him made in the Register of Voters and his signature/thumb impression obtained on that register, the second Polling Officer shall prepare a voter’s slip for that elector in the following form:

Serial No. of elector as per Col. (1) of the Register of Voters

Serial No. of elector as entered in the electoral roll

Initials of Polling Officer.....

- (ii) These Voter’ Slips will be printed by the Returning Officer in a paper of half the dimension of a post-card and will be supplied to you, as one of the items of polling materials, in stitched bundles of hundred slips and/or fifty slips each, having regard to the number of electors assigned to your Polling Station.
- (iii) The voter’ slips prepared by the second Polling Officer in respect of each elector as mentioned above shall be delivered by him to that elector and the elector shall be directed to proceed to the third Polling Officer who is in-charge of the Control Unit of the voting machine.
- (iv) These voter’ slips collected from the voters should be tagged serially and after the completion of the poll, the same should be kept in a separate envelope provided for the purpose.

4.5. RECORDING OF VOTES AND VOTING PROCEDURE

4.5.1 RECORDING OF VOTE

- (i) After the second Polling Officer has issued the Voter’ Slip to the elector, the elector will come to the polling officer in charge of the Control Unit of the voting machine with the voter’ slip. The elector will be allowed to vote only on the basis of such voter’ slip.
- (ii) It is absolutely essential that the electors go to the Voting Compartment to record their votes in the voting machine in exactly the same sequence in which they have been entered in the Register of Voters. You or the polling officer in-charge of Control Unit should, therefore, allow a voter to proceed to the Voting Compartment strictly according to the serial number mentioned in the voter’s slip.
- (iii) If it has not been possible to follow such exact serial order in respect of any elector, due to any exceptional circumstance or unforeseen or unavoidable reason, a suitable entry showing the exact serial number at which he has voted should

be recorded in the remark' column of the Register of Voters against the person concerned. Similar entries should also be made in respect of the subsequent voters whose serial order has been disturbed thereby.

4.5.2 PERMITTING ELECTOR TO RECORD VOTE

- (i) When the elector comes with the voter slip to the Polling Officer in-charge of Control Unit, the voter's slip will be taken from him, and he will be allowed to vote.
- (ii) All voter slips collected from electors shall be carefully preserved and kept in a separate cover at the end of poll. The Returning Officer will provide a special cover for the purpose, which will be sealed and secured in the manner as directed in **Chapter – 7**.
- (iii) Immediately after the voter slip has been collected from the elector, his left index finger shall be checked by you/third Polling Officer in-charge of the Control Unit. If the indelible ink mark made thereon is indistinct or has been removed, the same shall be marked again, so as to leave a clear indelible mark.
- (iv) The elector shall then be directed to proceed to the Voting Compartment to record his vote.

4.5.3 VOTING PROCEDURE

- (I) To enable the elector to record his vote, the Ballot Unit(s) kept in the Voting Compartment has to be activated. For this purpose, the 'Ballot' button on the Control Unit shall be pressed by you/third polling officer in-charge of that unit. On the 'Ballot' button being pressed, the 'Busy' lamp in the Control Unit will glow red and simultaneously the 'Ready' lamp on each Ballot Unit in the Voting Compartment will start glowing green. This will indicate that the Ballot Unit of the Electronic Voting Machine is now ready to record the vote according to the choice of the elector.
- (ii) The elector will record his vote in the Voting Compartment by pressing the 'lue Button' provided on the Ballot Unit against the name, photograph and symbol of the contesting candidate of his choice. When he presses that button, the lamp provided on the Ballot Unit against the name, photograph and symbol of that contesting candidate will start glowing red and green light on the Ballot Unit will go off. The VVPAT will print a small slip of paper that carry the symbol, name and serial number of the candidate voted which will be visible for seven seconds in the VVPAT window. Thereafter, the printed paper slip will automatically get cut and fall in sealed drop box of the VVPAT. Also, a beep sound will be heard from the Control Unit. After a few seconds, the beep sound and the red light in the candidate' lamp on the Ballot Unit and the red light in the 'Busy' lamp on the Control Unit will also go off.
- (iii) If there is a complaint with respect to candidate lamp of the Ballot Unit at the time of voting, the EVM with VVPAT should be replaced immediately and the matter reported to the Commission.
- (iv) These visual and audio signs are indicative of the fact that the voter inside the Voting Compartment has recorded his vote. The voter should forthwith come out of the Voting Compartment and leave the Polling Station.
- (v) The above procedure will be repeated in respect of all electors. It should be ensured that only one voter at a time goes inside the Voting Compartment to vote. It should also be ensured that after an elector records his/her vote, the 'Ballot' button on the Control Unit is pressed for the next voter only when the earlier voter has come out of the Voting Compartment.
- (vi) If an elector after having recorded his vote alleges that the paper slip generated by the VVPAT has shown the name or symbol of a candidate other than the one he voted for, the Presiding Officer, shall follow the steps mentioned in **5.9 of Chapter – 5**.

4.5.4 TALLYING OF NUMBER OF VOTES POLLED PERIODICALLY

- (I) At any time, if the total number of votes polled up to that time has to be ascertained, the ‘Total’ button on the Control Unit should be pressed. The display panel on the Control Unit will then show the total number of votes polled by that time. This should be done periodically and tallied with the number of electors allowed to vote up to that time as reflected in the Register of Voters.
- (ii) In any event, you must ascertain and tally the number of votes polled during every two hours interval and record the number of votes polled in the relevant columns in the Presiding Officer’s diary. The ‘Total’ button should be pressed only when the busy lamp is not on, i.e. only after the elector allowed to vote has recorded his vote, and before the next elector is allowed to vote by pressing the Ballot button. Otherwise, the figure showing the total number of votes polled by that time will not appear on the Display Panel.

4.5.5 PRESIDING OFFICER’S PRIVILEGE TO ENTER THE VOTING COMPARTMENT DURING POLL

- (i) You are likely to suspect in course of the poll process that (i) the BU (Ballot Unit) (screened from your view in the Voting Compartment) is not functioning properly (ii) or that an elector inside the Voting Compartment is trying to tamper or interfere with the BU (iii) or the elector inside is trying to paste paper, tape etc., on the symbols/ names/ ballot button of the BU (iv) or the elector is inside the Voting Compartment for an inordinately long period. You (i.e., the PrO) enjoy the special privilege to enter the Voting Compartment for inspecting the BU in such cases, in order to undertake remedial measures to ensure that the BU could not be tampered with or interfered with or that no obstruction whatsoever could be put in the way of the smooth and orderly functioning of the BU, and that the poll process could continue smoothly and orderly. But you must take care to enter the Voting Compartment, in the close presence of the Polling Agents only, irrespective of your special privilege. **(Rule 49Q of the Conduct of Election Rules, 1961)**.
- (ii) However, you must not enter the Voting Compartment at the time of polling to explain to the illiterate voters about how to use EVM. The District Election Officers have been instructed to supply a printed sample of EVM Ballot Unit pasted on a cardboard (real size) to all the Presiding Officers along with other polling materials at the time of dispatch. While printing such model Ballot Unit, he will take care to ensure that only dummy name and dummy symbols that are not in use, are used and not any real names or symbols. It will be printed in colour so that “blue button”, “green light” and “red light” etc. are clearly represented. Whenever any voter asks for help or expresses inability to vote using EVM, you can explain to him the voting process using the cardboard model of the EVM Ballot Unit in such a manner that the voter is able to understand. This will be done outside the Voting Compartment only in the presence of Polling Agents and never inside the Voting Compartment. You or your other polling staff shall not go frequently in the Voting Compartment, as that may give scope for complaints.

4.6 HANDLING OF EVM & VVPAT DURING POLL

4.6.1 REPLACEMENT OF UNITS DURING ACTUAL POLL

(Switch OFF CU before any sort of replacement)

- (i) During the poll, there may arise compelling circumstances, which render it necessary to use new (replacement of the current ones) EVM and VVPAT machines. In such an eventuality, you are required to read out a further declaration prescribed in Part II of **Annexure - 6** (Declaration by the PrO at the time of use of subsequent voting machine).

- (ii) If the Ballot Unit (BU) or the Control Unit (CU) does not function properly in course of the actual poll, the replacement of the whole EVM combination (inclusive of the CU, the BU and the VVPAT, i.e., all the three) becomes unavoidable. In such an eventuality, the mock poll shall be conducted as described in para 3.3 of chapter 3, differences in some steps are given below: -
- a) Casting of only one vote to each of the contesting candidates (including that for the NOTA option).
 - b) You must write “VVPAT paper slips pertaining to Mock Poll conducted in event of the replacement of the whole EVM and VVPAT set” on the envelope containing VVPAT paper slips.
 - c) You must sign Presiding Officer’s Report Part-I of Annexure-5 (Mock Poll Certificate) again and also submit a report in Part-V of Annexure-5 the Presiding Officer’s Report.
- (iii) In case only the VVPAT is replaced during the actual poll, no mock poll needs to be conducted.
- (iv) If the power pack of control Unit is to be replaced during mock poll or during actual poll or after the completion of the poll, Presiding Officer shall inform the Sector Officer, replace the power pack of CU in presence of Polling Agents and Sector Officer and again seal the Battery Section of CU with Address Tag and obtain their signatures. Presiding Officer shall submit a report in **Part-II of the Presiding Officer’s Report (Annexure – 5)**.
- (v) In case Display Panel of the CU displays “Link Error”, (i) Check that the cable connections are proper by visual inspection (don’t remove and reconnect the connectors)
- (vi) If “Link Error” still persists, replace the complete set of EVM and VVPAT.
- (vii) If CU shows “Low Battery” for VVPAT, then replace power pack of VVPAT. No Mock poll required.
- (viii) If VVPAT does not work properly, replace VVPAT only. In this case No mock- poll is required to be undertaken.
- (ix) If VVPAT has not printed the paper slip, or the printed paper slip remains uncut, then
- (a) Do not try to remove/cut hanging slip from the paper roll, no effort should be made to make it fall into the drop box. It should be allowed to remain hanging as it means that the vote has not been recorded in Control Unit and as it is not to be counted at the time of counting of the printed-paper slips. The details of such an occurrence should be clearly recorded in the Presiding Officer’s dairy diary in the following format:
 - The date and time of the occurrence.
 - The name of the voter and his serial number in the part in the electoral roll, who was allowed to cast his vote after replacement of VVPAT.
 - Whether the voter cast his vote after replacement of VVPAT or went away without casting his vote.
 - The Total number of votes cast before the occurrence.
 - (b) The last voter is allowed to cast his vote after the replacement of VVPAT.

- (x) Presiding Officers should be careful while preparing the **Part-V of the Presiding Officer's Report** to fill proper error code, like, 2.6 cutter error/2.7- fall error and also to mention beep sound is heard or not, busy lamp of CU keeps glowing etc. Non-compliance of the same shall lead to disciplinary action against them.

4.6.2 REPORTS TO BE PREPARED FOR REPLACEMENT OF EVM/VVPATs

Presiding Officer's Report to be obtained on Poll Day: -(Annexure 5)

- (i) Part-I (Mock Poll Certificate) To be filled after completion of every Mock poll on Poll Day.
- (ii) Part-II (Replacement of Power Pack of the Control Unit): To be filled whenever Power Pack of the Control Unit is replaced.
- (iii) Part-III (Pressing of Close Button after completion of Poll Certificate): To be filled after completion of Poll.
- (iv) Part-IV (EVM/VVPAT replacement Report, if replaced during Mock Poll). To be filled during mock poll, if any BU/CU/VVPAT replaced.
- (v) Part-V (EVM/VVPAT replacement Report, if replaced during Actual Poll). To be filled during actual poll, if any BU/CU/VVPAT replaced.

4.6.3 COLLECTION OF PRESIDING OFFICER'S REPORT

- (i) **Part-I, Part-II and Part-III of the Presiding Officer's Report** shall be kept in an envelope. The Presiding Officer shall deposit the said envelope along with EVM, VVPAT and other election material at Collection Centre.
- (ii) **Part-IV and Part-V of the Presiding Officer's Report** shall be collected by the Sector Officer, whenever any replacement is done. Sector Officers shall submit the said Reports to the Returning Officer.

CHAPTER – 05

SPECIAL CASES

Presiding Officer may face some special situations on poll day during poll process which needs different procedure to handle. Some of them special cases are as follows:

- (i) **Refusal to obey the voting procedure**
- (ii) **Voting by Blind and Physically Infirm Voters**
- (iii) **Electors Deciding Not to Vote**
- (iv) **Voting by Public Servants on Election Duty**
- (v) **Voting by Proxy**
- (vi) **Tendered Vote**
- (vii) **Challenged Votes**
- (viii) **A person whom you consider much below the qualifying age**
- (ix) **Test Vote**

5.1 REFUSAL TO OBEY THE VOTING PROCEDURE

- 5.1.1. PO ensures that an elector permitted to vote shall maintain absolute secrecy of voting inside the Polling Station. He shall strictly obey the voting procedure (**Cf. Chapter 4.5.3**).
- 5.1.2. If an elector refuses to obey the voting procedure, even after a warning issued by you, such an elector shall not be allowed to vote (**Cf. Rule 49M of the Conduct of Elections Rules, 1961**). If the elector had already been issued the voter slip, it must be withdrawn from him and cancelled.
- 5.1.3. The aforementioned violation of the voting procedure by an elector, will be recorded as follows – “Not allowed to vote – voting procedure violated”- shall be written by you in the remark’s column of the ‘Register of Voters’ (Form 17A) against that elector’s entry. You must put your full signature below that entry. No change shall, however, be made in the serial number of that elector (or of any succeeding elector) in column (1) of the ‘Register of Voters’.

5.2. VOTING BY BLIND AND PHYSICALLY INFIRM VOTERS

- 5.2.1. If you are satisfied that a blind elector can not recognize the symbols of the contesting candidates on the ballot paper on the BU (Ballot Unit) or a physically infirm elector can not record his vote by pressing the proper button thereon, you must permit that elector to take with him a companion not less than 18 years of age (but, carrying an EPIC Card/any alternative authorised ID) to the Voting Compartment for recording the vote according to his choice and on his behalf.
- 5.2.2. Physically Infirm Electors who can easily press the button on the BU (Ballot Unit) in favour of their preferred contesting candidate, must be permitted the authorised companion to lead them up to the Voting Compartment, but not inside it.
- 5.2.3. No person shall be permitted to act as a companion of more than one elector at any Polling Station on the same day.
- 5.2.4. The authorised companion is covered by the indelible ink protocol for the poll day. Indelible ink shall be applied to the right-hand index finger of the authorised companion. The right-hand index finger of the authorised companion must first be examined to confirm it for it being already marked or not with the indelible ink. If the right-hand index-finger is already marked with the indelible ink, such person can not be permitted to act as the authorised companion for the concerned elector (**Rule 49N- Registration of Electoral Rules, 1960**).

- 5.2.5. Before granting permission to act as an authorised companion of a blind or physically infirm elector, such a person must declare in writing that he will not divulge in whose favour the concerned elector cast his vote. He shall also declare in writing that he has not already acted as the companion of any other elector at any other Polling Station on that day. **(Annexure- 18)** [for the Form in which to make the declaration].
- 5.2.6. You must keep a record of electors who voted with the assistance of an authorised companion (Form 14A) {Cf. Sub-Rule (2) of Rule 49N). Cases where an authorised companion merely led up to the Voting Compartment (but did not enter), shall not be included in Form 14A.
- 5.2.7. You must keep a record of all such cases in Form 14A. This filled-up Form 14A, will be kept in an envelope super-scribed with **“SCRUTINY COVER”(WHITE COLOR)** and it is to be deposited at the Receipt Centre subsequent to the close of the poll.
- 5.2.8. Under no circumstance, shall a member of your polling staff, act as a companion to a blind elector to cast vote on his behalf.
- 5.2.9. You must ensure that the authorised voting companion leaves the Polling Station immediately after assisting the concerned elector.
- 5.2.10. You should ensure the Braille signage to these voters.

5.3. ELECTORS DECIDING NOT TO VOTE

- 5.3.1. If an elector, subsequent to his electoral roll number duly entered in the ‘Register of Voters’ Form 17A) as well as his signature/ thumb impression duly taken, decides not to vote, he shall not be forced to cast his vote.
- 5.3.2. A remark to the effect that he has decided not to vote, i.e., – “Refused to Vote”- shall be made by you in the remark’s column against his entry in the ‘Register of Voters’. You must put your full signature below that remark. In part I of the Form 17C, in place of Under Rule 49(O) in item 3, Left without voting or refused to vote will be inserted for those electors who after signing in ‘Register of Voters’(Form 17A) wish to leave without voting.
- 5.3.3. The signature or thumb impression of the elector shall also be obtained against such remark.
- 5.3.4. It shall, however, not be necessary to make any change in the serial number of the elector or of any succeeding electors in column (1) of the Register of Voters.
- 5.3.5. If the “allot” button on the Control Unit has been pressed to make the Ballot Unit ready for recording a vote by an elector but he refuses to vote, either you/third Polling Officer, whoever is in-charge of the Control Unit, should direct the next voter straightaway to proceed to the Voting Compartment to record his vote after entering necessary remark in ‘Register of Voters’ Form 17A) as per **para 5.3.2** above.
- 5.3.6. If the “allot” button on the Control Unit has been pressed to release voting on the Ballot Unit for the last elector but he refuses to vote, in that case as a first step, you/third Polling Officer, whoever is in-charge of the Control Unit shall put the ‘Power’ switch in the rear compartment of the Control Unit to ‘OFF’ position and disconnect the VVPAT from the Control Unit. In the second step, after disconnecting the VVPAT from the Control Unit, the ‘Power’ switch should again be put ‘ON’ Now the ‘Busy’ lamp will go off and the ‘Close’ button will become functional to close the poll. If this whole process is not followed in such a case, the **“Close”** button will not be functional and without closing the Control Unit, it will not give the result, because the ‘Result’ button will also become functional only after the ‘Close’ button is pressed.

5.4. VOTING BY PUBLIC SERVANTS ON ELECTION DUTY

- 5.4.1. Usually, No polling person is assigned polling duties in an Assembly Constituency in which he is posted or in which he is a resident or in his home constituency. The public servants appointed to perform the election duty, are provided the option to cast their vote through the postal ballot. They will apply in Form 12 to avail this option/facility.
- 5.4.2. The District Election Officer/Returning Officer will issue the order of appointment for

you to perform duties as the PrO (Presiding Officer) in duplicate. With this order, will be sent a sufficient number of Form 12 to you, to cater to your need as well as those of the Polling Officers (PO1, PO2, Po3...) (for applying for the Postal Ballot option/ facility).

5.4.3. You must send the filled-up Form 12 by addressing the Returning Officer (RO) along with a photocopy of your appointment. You have the option to submit your filled-up Form 12 with a copy of your appointment order at the election training venue (authorised official/ designated counter). After postal ballot is issued to the Polling Staff, the Returning Officer will make arrangement to facilitate their voting and depositing the ballot paper and the connected papers at the training centres itself, so that you do not have to post the ballot paper in post offices. Some poll officials may be posted in their home constituency (AC or PC) (i.e., where there are enrolled as electors), shall be granted the EDC (Election Duty Certificate) on application in Form 12A. They will be eligible to cast their vote through the EVM-VVPAT at the Polling Station, where they are discharging their election duty on the poll date. If their election duty is cancelled after the entry EDC is made against their names in the marked copy of electoral roll, they should not be deprived of the right to exercise their vote. Such persons whether an election official or any other public servant on election duty, to whom an EDC has been issued, should be allowed to cast his/her vote at any Polling Station other than the one in which but for the issue of such election duty certificate he/she should have been entitled to vote, including the Polling Station where he/she was originally posted for duty.

5.4.4. You (including PO1, PO2, PO3...) must apply through Form 12 for postal ballot at least 07 days (seven days or a week) prior to the poll date in your Assembly/ Parliamentary Constituency.

5.4.5. Voting by an EDC Elector (an elector producing an EDC):

- (a) Name of such elector shall be entered after the name of the last regular elector in the 'marked' voter list.
- (b) After this entry, the concerning officer will be the voter of this voter list, now he will cast his vote like other voters of the list.
- (c) The voter will go to first Polling Officer who will explain Polling Agents about this voter.
- (d) The second polling officer will enter the details of voter in the 'Register of Voters' (Form 17A) as under:

For example, the name of voter is Mukesh, part number of voter list is 32 and Sr. No is 625 then the entry in second column of 'Register of Voters' (Form 17A) will be:

625/32/AC number

5.5. VOTING BY PROXY

5.5.1. Certain categories of Service Voters have been extended the facility of 'Voting through Proxy', authorised by themselves. Such electors are called "Classified Service Voters" (CSVs). You will be supplied with a list of the CSVs, if any, for your Polling Station. This list of the CSVs is deemed to be a part of the 'marked' voter list for your Polling Station. Therefore, you must treat the proxy as if the actual Service Voter is present in front of you.

5.5.2. Certain categories of Service Voters have been extended the facility of 'Voting through Proxy', authorised by themselves. Such electors are called "Classified Service Voters" (CSVs). You will be supplied with a list of the CSVs, if any, for your Polling Station. This list of the CSVs is deemed to be a part of the 'marked' voter list for your Polling Station. Therefore, you must treat the proxy as if the actual Service Voter is present in front of you.

5.5.3. In the case of a proxy, the number to be entered in the second column (meant for the serial

number of electors) of the ‘Register of Electors’ (Form 17A), shall be his serial number as allotted in the CSV List. To distinguish this number from the serial numbers of electors, the letters ‘PV’ (acronym for ‘Proxy Voter’) must be put as a suffix inside a bracket. Illustration: - Let a proxy voter be at serial number 1 of the CSV List, in his case, the number to be entered in column 2 of Form 17A will be ‘1 (PV)’ Similarly, a proxy voter at Sl. No.5 of the CSV List, shall be entered as ‘5 (PV)’ and so on....

5.6. TENDERED VOTE

5.6.1. There is a possibility that a person may seek to cast vote in the name of an elector in the ‘marked’ voter list (he may be a genuine elector; a case of an error or a mistake; or, in a rare instance, even an impersonator), whose vote is already cast as per the ticking- formality recorded upon the ‘marked’ voter list by the PO1 (custodian of the ‘marked’ voter list). You must fully satisfy yourself about the identity of that person with reference to the already ticked (claimed) name in the ‘marked’ voter list, by means of a thorough cross-questioning in the light of the identifying documents presented at that time in support. By the end of the aforementioned procedure, if you become confident about the identity of the elector, you must allow him to vote through a tender ballot (but in no circumstance must you allow him to vote through the EVM-VVPAT machine). Such a vote shall be called a ‘tender vote’.

5.6.2. Twenty (20) extra ballot papers, identical to the one used in the BU (Ballot Units) of the EVM, shall be supplied (by the Returning Officer) for use as tendered ballots, in case of need. If the need for tender votes exceeds 20, the extra requisition shall be fulfilled by the Returning Officer, but only on a demand by you (i.e., the PrO) through the concerned Sector Officer/Sector Magistrate.

5.6.3. Before handing the tender ballot to the elector for voting, you must write down in your own hand the words “Tender Ballot Paper” on the back of the ballot, (unless this same language is not already stamped there).

5.6.4. Account of Tendered Ballot Papers:

You must keep an accurate account of all the ballot papers under the headings (i) total received (ii) total issued, and (iii) unused and returned, in Item 9 of the Part I of Form 17C.

5.6.5. Record of Voters to Whom Tendered Ballot Papers Issued:

- (i) You must maintain the complete record of the electors issued with tender ballot in Form 17B. You must obtain the signature or thumb impression of the elector in Column (5) of the Form 17B before handing him a tender ballot
- (ii) You must also hand the elector an inked arrow cross seal to cast his vote. This seal is identical to one used for marking ballots in the earlier prevalent ballot box-based conventional system of voting. The arrow-cross seal shall be an integral part of the ‘Polling Station Kit’ supplied to you (by the RO).
- (iii) On receiving the tendered ballot paper, the concerned elector will go into a separate Voting Compartment (specially meant for it), and will mark his vote on the ballot by putting the arrow cross seal on the symbol of the contesting candidate of his choice.
- (iv) Thereafter, the elector will fold the tender ballot in a manner that the arrow-cross seal mark, made by him, does not spill around, and, finally coming out of the Voting Compartment, hand it over to you.
- (v) You must keep all the tender ballots and the list thereof (prepared in Form 17B) in an envelope, specifically provided for the purpose and seal the same at the close of the poll.
- (vi) If a blind or a physically infirm elector is unable to record his vote without assistance, you must permit him to take with him a companion in accordance with the procedure laid down in this Chapter.
- (vii) **You must not make any entry in Voter Register 17A w.r.t the Tendered Vote.**

5.7. CHALLENGED VOTES

5.7.1. The identity of a person claiming to be a particular elector may be challenged by a polling agent, by depositing Rs 2/- (two rupees) in cash. You must determine the challenge through a summary inquiry. If the challenge is not sustained, you must allow the challenged person to cast his vote. If the challenge is sustained, you must not only refuse the challenged person from voting, but also hand him over to the police along with a complaint in writing.

5.7.2. **Challenging a Voter's Identity:**

Unless there arise compelling grounds to indicate that an elector is a bogus voter, he is to be deemed to be a genuine elector. You must determine any such case through a summary inquiry.

5.7.3. **Challenge Fee:**

Under no circumstance, must you entertain a challenge to an elector's identity, unless the concerned polling agent deposits Rs 2/- (two rupees) in cash. You must issue a receipt therefore in the name of the challenger in the prescribed Form (**Annexure - 19**).

- (i) You must warn the presumed elector challenged, about the penal consequences of impersonation
- (ii) Next you must read out each entry in sequence related to the elector being claimed in the 'marked voter list', and challenge the presumed elector whether it relates to him and
- (iii) Finally enter his name and his address in the list of Challenged Votes (i.e. Form 14) and ask him to sign or put his thumb impression thereupon. You shall not allow him to vote if he refuses to comply with.

5.7.4. **Summary Inquiry:**

You must ask the challenger to furnish evidence to prove that the challenged person is not the elector he claims to be. If the challenger fails to establish his case, the challenge stands dismissed and you must permit the challenged person to cast his vote. If the challenger establishes his case, you must ask the challenged person to rebut the challenge, i.e. to prove that he is the elector that he believes himself to be. If the challenged person can prove the case in his favour, you must permit him to cast his vote. But, if he fails to prove his case, the challenge stands established. You may seek the statement of a responsible officer of the area, a neighbour of the challenged person (brought to your notice) or any other person present who is likely to throw light in the matter. If the challenge is firmly established, you must hand over the challenged person to the custody of a policeman on duty there, along with a complaint in writing (**Annexure - 20**), addressed to the Station House Officer of the Police Station of your Polling Station area.

5.7.5. **Return or Forfeiture of Challenge Fee:**

If the challenge is found to fall through in the Summary Enquiry, the challenge fee of Rs 2/- shall be forfeited; while the word "forfeited" will be noted in Column 10 of Form 14 as well as the relevant counterfoil in the receipt book (the depositor's signature or thumb impression, not to be taken). While in case of the challenge is found to stand, the challenge fee of Rs 2/- is to be returned to the challenger, after his signature acknowledging the receipt of Rs 2/- in Column 10 of the Form 14 – i.e. the "**LIST OF CHALLENGED VOTES**" as well as upon the counterfoil of the relevant receipt in the receipt book.

5.8. **PERSON WHOM YOU CONSIDER MUCH BELOW THE QUALIFYING AGE**

5.8.1. In the case of a person whom you consider much below the qualifying age, you must clearly be satisfied about his claim of **being an elector with reference to the entry in the electoral roll** relating to him.

5.8.2. If you are prima facie satisfied about his identity and the fact of inclusion of his name in the electoral roll but consider him to be below the minimum voting age,

you should obtain a declaration as in **Annexure - 15** from that elector about his age on the 1st day of either January/April/July/October depending on the time on elections with reference to which the existing electoral roll of the constituency has been prepared/revised. Before obtaining the declaration from such elector, you should inform him of the penal provision in Section 31 of the Representation of the People Act, 1950, for making false declaration.

- 5.8.3. You should also prepare a list of voters from whom you have obtained such declarations in **Part I of Annexure - 16**. You should also maintain a list in **Part II of the said Annexure - 16** of those voters who refuse to give the aforesaid declaration and go away without casting their votes. After the close of the poll, the above-mentioned list and the declarations should be kept together in a separate cover.

5.9. TEST VOTE

- 5.9.1. If an elector after having recorded his vote under Rule 49MA alleges that the paper slip generated by the VVPAT has shown the name or symbol of a candidate other than the one he voted for, the Presiding Officer shall follow the steps mentioned below:
 - 5.9.2. Obtain a written declaration (**Annexure - 17**) from the elector as to the allegation, after warning the elector about the consequence of making false declaration. If the elector gives the written declaration referred to in sub –rule (1), the Presiding Officer shall make a second entry related to that elector in Form 17A, and permit the elector to record a test vote in the voting machine in his presence and in the presence of the candidates or Polling Agents who may be present in the Polling Station and observe the paper slip generated by the VVPAT. If the allegation found true, the Presiding Officer shall report the facts immediately to the Returning Officer, stop further recording of votes in that voting machine and act as per the direction that may be given by the Returning Officer.
 - 5.9.3. If, however, the allegation is found to be false and the paper slip so generated under sub rule (1) matches with the test vote recorded by the elector under sub rule (2), then, the Presiding Officer shall make a remark to that effect against the second entry relating to that elector in Form 17A mentioning the serial number and name of the candidate for whom such test vote has been recorded and obtain the signature or thumb impression of that elector against such remarks and make necessary entries regarding such test vote in item 5 in part I of Form 17C (**Annexure - 8**).

CHAPTER - 6

ADJOURNMENT/STOPPAGE OF POLL DUE TO RIOT BOOTH CAPTURING, ETC

6.1. ADJOURNMENT OF POLL DUE TO RIOT ETC

- 6.1.1. Under section 57(1) of the Representation of People Act, 1951, the Presiding Officer of a Polling Station is empowered to adjourn the poll on account of
- (i) a natural calamity like flood, heavy snowfall, a severe storm and the like, or
 - (ii) non-receipt or loss or damage to essential polling materials like voting machine, authentic copy of electoral roll and the like, or
 - (iii) disturbance of peace at the Polling Station making it impossible to take the poll, or
 - (iv) non-arrival of the Polling Party at the Polling Station due to obstruction on the way or any other serious difficulty, or
 - (v) any other sufficient cause.
- 6.1.2. If there is a riot or any attempt of open violence, use police force to control the same. If, however, it can not be controlled and it is impossible to continue the poll, you should adjourn the poll. As stated above, the poll should also be adjourned if the conduct of the poll is rendered impossible on account of any natural calamity or other sufficient cause. A passing shower of rain or strong wind would not normally be a sufficient cause for adjournment of poll. The discretion given to you to adjourn the poll should be exercised most sparingly and only in cases where it has become physically impossible to conduct the poll. The Commission has, however, decided that an adjourned poll may be ordered at all those Polling Stations where polling fails to start within two hours of the time scheduled for the commencement of poll.
- 6.1.3. In every case of adjournment of poll, you must report immediately the full facts to the Returning Officer. Wherever a poll is adjourned, announce formally to all, who are present at the Polling Station that the poll will be taken on a day to be notified subsequently by the Election Commission.
- 6.1.4. Both the units of the voting machine, VVPAT and all election papers should be sealed and secured in the presence of the Polling Agents as if the poll has come to close in the normal way

6.2. COMPLETION OF ADJOURNED POLL

- 6.2.1. Where the poll has been adjourned at a Polling Station, under the provisions of sub-section (1) of Section 57 of the R.P. Act 1951, the adjourned poll will recommence on the date and time fixed by the Election Commission from the stage at which it was left immediately before the adjournment, i.e. the electors, who have not already voted before the poll was adjourned, will alone be permitted to vote at the adjourned poll. The Returning Officer will provide the Presiding Officer of the Polling Station, where such adjourned poll is taken, with the sealed packets containing the same marked copy of the electoral roll and the Register of Voters in Form 17A, which were earlier used at that Polling Station, and a new voting machine and VVPAT.
- 6.2.2. Before the recommencement of the adjourned poll, the sealed packet containing the marked copy of the electoral roll and the Register of Voters should be reopened by you in the presence of the contesting candidates or their agents, who may be present at the Polling Station, and this very same marked copy of the electoral roll and the Register of Voters should be used for completion of adjourned poll.
- 6.2.3. The provisions of Rules 28 and 49A to 49V will apply to the conduct of an adjourned poll also as they apply to the poll before it was so adjourned.
- 6.2.4. Where the poll could not be commenced due to non-arrival of the Polling Party or other reasons, the provisions of above-mentioned rules will apply to every such adjourned poll as they apply to the original poll.

6.3. STOPPAGE OF POLL FOR FAILURE OF EVM, BOOTH CAPTURING ETC

- 6.3.1. Under Sections 58 and 58A of the Representation of the People Act, 1951, the Election Commission has been given power to declare the poll at a polling station to be void and direct a fresh poll, if at that polling station:
- a. any voting machine has been unlawfully taken away by any unauthorized person, or
 - b. any voting machine has been accidentally or intentionally destroyed or lost or damaged or tampered and the result of the poll at that polling station can not be ascertained for that reason, or
 - c. any voting machine develops a mechanical failure during the course of the recording of votes, or
 - d. any error or irregularity in procedure, which may vitiate the poll, has been committed, or
 - e. there has been booth capturing (as defined in Section 135A of the said Act).
- 6.3.2. If any such thing happens at your polling station, you should report full facts forthwith to the Returning Officer, who will, in turn, report the matter to the Election Commission for its directions.
- 6.3.3. After considering all material circumstances, if the Commission directs fresh poll to be taken at a polling station, such fresh poll shall be taken in the same manner as the original poll. You will get instructions in this regard from RO.
- 6.3.4. All electors entitled to vote at the polling station in question will be entitled to vote again at the fresh poll. The marks of the indelible ink made at the original poll should be ignored at the fresh poll. The Commission has directed that the mark of the indelible ink, in case of a fresh poll, should be put on the voter's left-hand middle finger to distinguish the marks to be made at the fresh poll from those already made at the original poll.

6.4. CLOSING OF VOTING MACHINE IN CASE OF BOOTH CAPTURING

- 6.4.1. Rule 49X of the Conduct of Elections Rules, 1961 provides that where the Presiding Officer of a polling station is of the opinion that booth capturing is taking place at the polling station, he shall immediately close the Control Unit of the voting machine to ensure that no further votes can be recorded and shall detach the Ballot Unit(s) from the Control Unit.
- 6.4.2. PrO should resort to closing the voting machine as mentioned above only when you are certain that the booth capturing is taking place and not on a mere apprehension or suspicion about the possibility of booth capturing. This is so because once the Control Unit is closed by pressing the close button, the voting machine will not record any further votes and the poll will have to be necessarily adjourned either for the day or temporarily till the new voting machine is provided to you for the conduct of further poll at the Polling Station.
- 6.4.3. As soon as possible after you have closed the voting machine under Rule 49X of the Conduct of Elections Rules, 1961, you should immediately report the matter with full facts to the Returning Officer. The Returning Officer shall, in turn, report the full facts of such case to the Election Commission through the fastest means of communication available.
- 6.4.4. The Election Commission, on receipt of the report from the Returning Officer and after taking into account all material circumstances, may —
- a. either decide to have the adjourned poll completed from the stage it was adjourned by providing a new voting machine, if it is satisfied that the poll upto that stage was not vitiated, or
 - b. declare the poll at the polling station as void, if it is satisfied that the poll was vitiated, and direct a fresh poll at that polling station.
- 6.4.5. Where the poll is adjourned/stopped for the day by the closure of the voting machine under **para 6.4.1** above, the voting machine and all election paper shall be sealed and secured in the same manner as on the close of poll.
- 6.4.6. Further steps to complete the adjourned poll or conduct a fresh poll, as the case may be, as directed by the Commission, shall be taken in accordance with the procedure already mentioned above.

CHAPTER - 7

CLOSE OF POLL

7.1 VOTING BY PERSONS PRESENT AT THE POLLING STATION AT THE CLOSING HOUR

- 7.1.1. The poll should be closed at the hour fixed for the purpose, even if it had commenced somewhat later than the hour appointed for the commencement of poll owing to some unavoidable reason. This will not however, mean that after the hour fixed for closing the poll, no elector will be allowed to cast his vote. You have to keep in mind that all electors, who are present at the Polling Station at the hour appointed for the close of poll, should be permitted to cast their votes. In such case, poll has to be continued beyond the appointed closing hour till everyone has voted.
- 7.1.2. A few minutes before the hour appointed for closing the poll, announce to all those within the limits of the Polling Station who are waiting to vote that they will be allowed to record their votes in turn. Distribute to all such electors, slips signed by you in full, which should be serially numbered from serial No. 1 onwards according to the number of electors standing in the queue at that hour. The last elector should be given slip no. 1 and next voter in front of him/her shall get slip no.2 and so on. Continue the poll even beyond the closing hour until all these electors have cast their votes. Depute police or other staff to watch that no one is allowed to join the queue after the appointed closing hour. This can be effectively ensured if the distribution of slips to all such electors is commenced from the last elector standing in the queue and preceded backwards towards its head.

7.2. CLOSING OF POLL

- 7.2.1. After all the electors who may be present at the Polling Station at the appointed hour for closing the poll have voted as provided in the preceding para, you should formally declare the poll as closed and should not permit any person to vote thereafter under any circumstances.
- 7.2.2. **All Presiding Officers shall close the EVM by pressing ‘CLOSE’ button at the end of poll in the presence of Polling Agents as may be present.** When the ‘Close’ button is pressed the display panels on the Control Unit will show the total number of votes recorded in the voting machine till the end of the poll (but not the candidate-wise tally). The total number of votes recorded in the machine should be immediately noted in Item 6 of **Part I of Form 17C (Annexure – 8)**. The ‘Close’ button is provided in a compartment in the result section below the rubber cap on the left side of its outer cover and can be reached by simply pulling out the rubber cap. The rubber cap should be replaced after the ‘Close’ button has been pressed and the poll closed.
- 7.2.3. Once the ‘Close’ button is pressed, the voting machine will not accept any further votes. Therefore, before pressing the ‘Close’ button, you should be extremely cautious and absolutely certain that no elector, who was present at the hour fixed for the close of poll, remains to vote.
- 7.2.4. You should also note that the ‘Close’ button will function only when the ‘Busy’ lamp on the Control Unit is not ON i.e. only after the last elector allowed to vote has recorded his vote (by pressing the blue button on the Ballot Unit). If the ‘Busy’ lamp is ON by reason of the ‘Ballot’ button having been pressed by mistake after the last elector has recorded his vote or such last elector refusing to record his vote after the ‘Ballot’ button has been pressed for him, the ‘Busy’ lamp can be put off by switching off the ‘Power’ switch in the rear

compartment of the Control Unit and disconnecting the VVPAT from the Control Unit. After disconnecting the VVPAT from the Control Unit, the 'Power' should again be set to 'ON'. Now the 'Busy' lamp will go off and the 'Close' button will become functional.

7.2.5 At the time of closure of poll, the Presiding Officer shall make a note of the Poll end date and time displayed on the CU in the Presiding Officer's diary.

7.2.6. Prepare **Part-III of the Presiding Officer's Report (Annexure-5)** after closing of the poll.

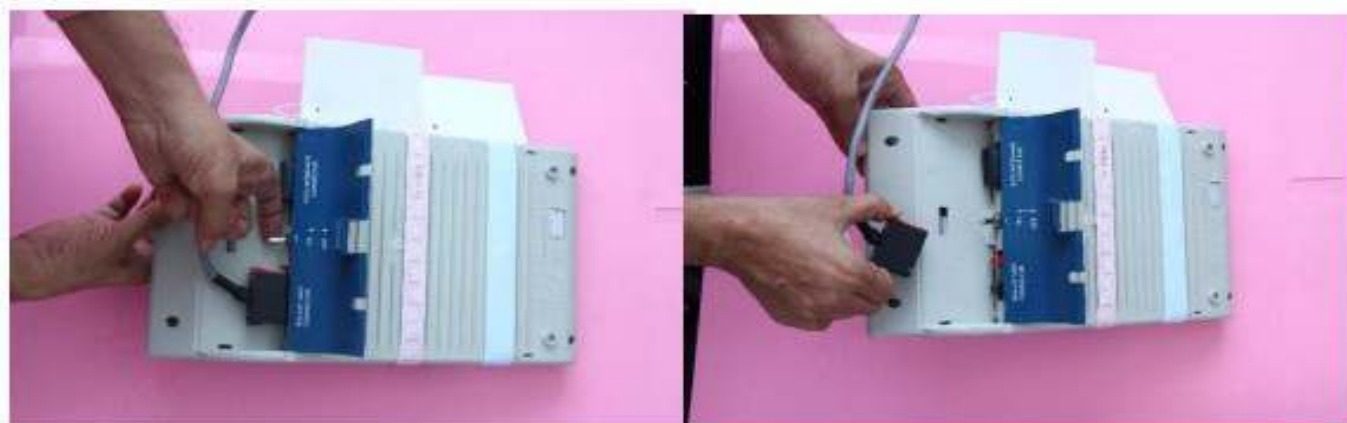

7.2.7 The Presiding Officer shall draw a line at the end of Poll after the last entry in Form 17A and shall record the signed statement thereafter "the serial number of last entry in form 17A is" and obtain the signatures of all Polling Agents as may be present, below this statement.

7.2.8. Presiding Officer will remove Power Pack (Battery) from VVPAT in the presence of Polling Agents. Only after removal of Power Pack (VVPAT), seal the carrying case of VVPAT in the presence of Polling Agents.

7.3. ACCOUNT OF VOTES RECORDED

7.3.1. PREPARATION OF ACCOUNT OF VOTES RECORDED

(i) After the close of poll, you are required to prepare in duplicate, under Rule 49S of the Conduct of Elections Rules, 1961, an account of votes recorded in the voting machine. Such account shall be prepared by you in **Part I of Form 17C**.

(ii) As already explained in para 7.2.2, the total number of votes recorded in the voting machine at the close of poll shall be ascertained by pressing the 'Close' button. If necessary, that button can again be pressed to get the required information.

(iii) You must not forget that the total number of votes recorded in the voting machine must be equal to the total number of voters registered as per column (I) of the Register of Voters (Form 17A) minus the number of voters who decided not to vote (as per the remarks column of that register) and also minus the number of voters not allowed by you to vote for violating the secrecy of voting/procedure of voting (as per the remarks column of the said Register). The test votes recorded, if any, under rule 49MA(2) are required to be mentioned at serial **No. 5 of part-I of form 17-C**.

(iv) Form 17C is given for your guidance at **Annexure – 8**.

(v) The account of votes recorded in Form 17C should be kept by you in a separate cover with the words 'Account of Votes Recorded' super scribed there in.

7.3.2 SUPPLY OF ATTESTED COPIES OF ACCOUNT OF VOTES RECORDED TO POLLING AGENTS

- (i) Under the said Rule 49S, you are also required to furnish to every polling agent, who is present at the close of the poll, a true attested copy of the account of votes recorded as prepared by you in Form 17C, after obtaining a receipt from those Polling Agents. Copies of the accounts should be furnished to every polling agent present even without his asking for it. The original Form 17C has to be deposited at the Collection Centre (**Polled EVM Strong Room**) along with the voting machine. The duplicate copy of Form 17C will also be deposited at the collection Centre.
- (ii) To enable you to make the required number of copies of the account of votes recorded in Form 17C you will be supplied with as many copies of the printed form (Form 17C) as the number of contesting candidates plus one or two more for the original account. If possible, you should prepare the required number of copies with the help of carbon paper, while filling in the entries in the original account itself, so that all such copies, supplied to Polling Agents and the original account are identical in every respect.
- (iii) In simultaneous elections to the Parliament (Lok Sabha) and State Legislative Assembly (Vidhan Sabha), it should be noted that account of votes recorded in Form 17C should be prepared separately for the Parliamentary (Lok Sabha) and State Assembly (Vidhan Sabha) elections. Copies of Form 17C for the assembly election should be given only to the agents of the contesting candidates contesting the assembly election and copies of Form 17C for the parliamentary election should be given only to the agents of contesting candidates for parliamentary election.

7.3.3. DECLARATION TO BE MADE AT THE CLOSE OF THE POLL

In order to ensure that above mentioned requirements of Rule 49S regarding furnishing of copies of account of votes recorded to the Polling Agents are fulfilled, a declaration in **Part III (Annexure - 6)** should be made and completed by you at the close of poll.

7.4. SEALING OF THE EVM AND VVPAT AFTER CLOSE OF POLL

- 7.4.1. After the poll has been closed and the 'account of votes recorded' in the voting machine has been prepared in Form 17C and copies thereof furnished to the Polling Agents present, the voting machine and VVPAT should be sealed and secured for transportation to the Receiving/collection centre.
- 7.4.2. For sealing and securing the voting machine and VVPAT, the power switch in the Control Unit should first be switched 'OFF' and then the Ballot Unit(s), the Control Unit and VVPAT should be disconnected. It should be ensured that the paper slip contained in the drop box of the VVPAT shall be intact. **Only after removal of Power Pack (VVPAT), seal the carrying case of VVPAT in the presence of Polling Agents.** The Ballot Unit(s), the Control Unit and VVPAT should now be put back in their respective carrying cases.
- 7.4.3. Each carrying case should then be sealed at both ends by passing a thread through the two holes provided for the purpose on both sides of the carrying case and putting thread seal with an address tag showing the particulars of the election, the Polling Station and the unit contained therein and carrying the Presiding Officer's signatures with date and seal on it.



- 7.4.4. The particulars on the address tag on the Control Unit, Ballot Unit and VVPAT shall be the same as mentioned in **para 3.2.1 of Chapter - 3**. The contesting candidates or their Polling Agents, who are present at the Polling Station and desirous of putting their seals on the address tag, should also be allowed to do so.
- 7.4.5. The names of the contesting candidates/Polling Agents who have affixed their seals on the address tags on the carrying cases of the Ballot Unit(s), Control Unit and VVPAT unit should also be noted by you in the declaration which you have to make at the close of the poll vide **Part IV of Annexure-6**.

7.5. SEALING OF ELECTION PAPERS

7.5.1. SEALING OF ELECTION PAPERS IN PACKETS

- (i) After the close of poll, all election papers relating to the poll shall be sealed in separate packets as required by Rule 49U of the Conduct of Elections Rules, 1961 (**Annexure-2**).
- (ii) All the packets so sealed, as mentioned in paragraph 7.5.2 shall be taken to the Receiving Centre and handed over to Returning Officer or Officer-in-charge at the Receiving centre cum Strong Room.
- (iii) The large **White cover** superscribed as “EVM papers” comprising (i) the unsealed envelope containing Account of votes recorded (Form 17C), (ii) Unsealed envelope containing the Presiding Officer Report-I (Mock poll certificate), II & III and (iii) Sealed Black envelope containing printed VVPAT paper slips of Mock poll shall be placed along with polled EVMs in the polled EVM Strong Room.
- (iv) You should allow each contesting candidate or his Election Agent or his Polling Agent, who may be present at the Polling Station, to affix his seals on the envelopes and packets containing the following documents:
 - a. the marked copy of electoral roll;
 - b. the Register of Voters;
 - c. Voter slips;
 - d. Used tendered ballot papers and the list of tendered votes in Form 17B;
 - e. Unused tendered ballot papers;
 - f. the list of challenged votes;
 - g. Unused and damaged paper seals, if any;
 - h. appointment letters of Polling Agents; and
 - i. any other papers that the Returning Officer has directed to be kept in a sealed packet.

7.5.2. PACKING OF STATUTORY, NON-STATUTORY COVERS AND ELECTION MATERIALS (ANNEXURE 22)

- (i) In order to avoid delay and the inconvenience of waiting at the place for depositing sealed voting machine, VVPAT, election papers and all other materials, you are advised to pack the covers and other materials in Six separate large packets, as explained below, and hand them over at the place appointed for receipt (Receiving Centre) thereof.
- (ii) Even if a statement or record to be mentioned in the statutory form or non-statutory form is 'Nil', such 'Nil' remark should be marked on the concerned statutory form or non-statutory form and placed in the respective envelopes and packed in the large packets provided for packing smaller envelopes as below. Thus, total number of six covers shall be made ready so that no necessity arises for the receiving official at the receiving centre to enquire about the non-production of any of the sealed/unsealed covers to be received by them.
- (iii) The First packet (coloured **WHITE**) should contain the EVM Papers as mentioned below and should be superscribed as "**EVM PAPERS COVER**"
 - a) Envelope containing the account of votes recorded (Form-17C),
 - b) Envelope containing the PrO Report I (Mock-Poll Certificate), II & III
 - c) Black color Sealed Envelope containing Printed VVPAT paper slips of Mock Poll

Note: All the above election papers should be kept in unsealed white coloured master envelope (Envelope No: 1/1) and should be kept in the Polled EVM Strongroom.

In case of simultaneous election, for assembly election, one additional Master envelope for EVM Papers in pink colour, one additional envelope for account of votes recorded (17C) in pink colour and one additional envelope for Presiding Officer's Report-I (Mock Poll Certificate), II & III in pink color and one additional envelope for VVPAT paper slips of Mock poll in black colour for assembly poll EVM.

- (iv) The Second packet (colored **WHITE**) should contain the unsealed/sealed envelopes mentioned below and should be superscribed as "**SCRUTINY COVER**"
 - a) Unsealed envelope containing the Presiding Officer's Diary
 - b) Sealed envelope containing the register of voters (17A)
 - c) Unsealed envelope containing Visit Sheet
 - d) Unsealed envelope containing the list of blind and infirm electors in Form 14-A and the declarations of the companions.

Note: All the above election papers should be kept in unsealed white coloured master envelope (Envelope No: 2/1) and Polling Station wise scrutiny cover required for **scrutiny should be stored separately in a strong room other than Polled EVM strongroom having polled EVMs and VVPATs.**

- (v) The Third Packet (colored **WHITE**) should contain the sealed envelopes mentioned below and should be superscribed as "**STATUTORY COVER**"
 - a) Sealed envelope containing the marked copy of the electoral roll and list of CSVs (if any)
 - b) Sealed envelope containing voter's slips.
 - c) Sealed envelope containing unused tendered ballot papers.
 - d) Sealed envelope containing the used tendered ballot papers and the list in Form 17-B
 - e) Sealed envelope containing challenged votes in Form 14

Note: In case of simultaneous election, for assembly election, one additional envelope for Voter's Slips (**Pink** Colour)- 01 Nos

- (vi) The Fourth packet (colored **YELLOW**) should contain the following covers and should be superscripted as "**NON-STATUTORY COVER**"
- a) Envelope containing the copy or copies of electoral roll (other than the marked copy)
 - b) Envelope containing the appointment letters of Polling Agents in Form 10
 - c) Envelope containing the election duty certificates in Form 12- B
 - d) Envelope containing declarations by Presiding Officer
 - e) Envelope containing receipt book and cash if any, in respect of challenged votes
 - f) Envelope containing the declarations obtained from electors as to their age and the list of such electors who have refused to make declaration as to their age
 - g) Envelope containing unused and damaged paper seals and special tags
 - h) Envelope containing unused voter's slips
 - I) Envelope containing Form of Declaration by elector under 49MA (Test Vote)
 - j) Envelope containing Form of Declaration by elector whose name is in ASD list
 - k) Envelope containing letter of complaint to SHO

Note: In case of simultaneous election, one additional envelope for declarations by the Presiding Officer may be given in pink color for assembly poll.

- (vii) The Fifth packet (colored **BROWN**) should contain the following items:
- a. The Handbook for Presiding Officer, Manual of Electronic Voting Machine and VVPAT, instructions etc.
 - b. Used and remaining Indelible ink set (with stopper having been secured on each phial effectively with molten candle or wax applied thereon to prevent leakage or evaporation)
 - c. Used Stamp pad (Brown colour)
- (viii) The Sixth packet (colored **BLUE**) should contain the following items:
- a) Candidate Information Booklet
 - b) Other unused forms
 - c) Metal seal of the Presiding Officer
 - d) The arrow cross-mark rubber stamp for marking tendered ballot papers;
 - e) Cup for setting the indelible ink.
 - f) All the other items, if any, should be packed into the Fifth packet (colored Blue).

7.5.3. SEALING OF COVERS

Each of the four smaller covers/packets to be included in the third packet marked "STATUTORY COVERS" should be sealed. Envelope containing the register of voters (17A) to be included in the second packer superscribed as "SCRUTINY COVER" and should be sealed. The other smaller covers/envelopes containing various non-statutory papers and items of election materials to be included in the fourth packets superscribed as "NON-STATUTROY COVERS" and may be prepared separately. It need not to be sealed except the cover containing the list of challenged votes in Form 14 in order to save time. All these unsealed covers and the sealed cover, containing list of challenged voters in Form-14,

should be simply placed in the respective bigger covers after tick marking at the top page of the bigger covers and signed by you. These bigger packets need not be sealed; but may be properly secured by means of pins or thread so that the contents may be checked at the collection centre. The third packet superscribed “Statutory Cover” should, however, be sealed by you after checking of the contents at the collection centre.

7.6. PREPARATION OF THE DIARY AND DELIVERY OF VOTING MACHINES, VVPAT AND ELECTION PAPERS AT THE COLLECTION CENTRES

7.6.1. PREPARATION OF THE DIARY

- 7.6.1.1. You should record the proceedings connected with the conduct of poll in the polling station in the diary to be maintained for the purpose. The proforma of the diary is reproduced at **Annexure - 7**. However, you will be furnished with a serially numbered proforma of the diary and should use only that proforma.
- 7.6.1.2. You must go on to record the relevant events as and when they occur. You should mention all important events therein. You should be careful while recording the events in the diary. If any incident takes place at the polling station, which is not reported by you, but is reported by any other source, the Election Commission shall certainly take necessary action in the matter and may even contemplate taking disciplinary action against you.
- 7.6.1.3. Keep on making necessary entries in the relevant columns of the diary at regular intervals or from time to time as envisaged. It has been observed in many cases that the Presiding Officers do not make the entries in the relevant columns of the diary at regular intervals or from time to time as envisaged and fill in all entries and complete the diary at the end of the poll. This is highly objectionable. It should be noted that any lapse on your part in the proper maintenance of diary at all points of time during the process of poll will be viewed very seriously by the Commission.

7.6.2. TRANSMISSION OF EVM, VVPAT AND ELECTION PAPERS TO THE RETURNING OFFICER

- 7.6.2.1. After the EVM and VVPAT and all election papers have been sealed and secured by you after the close of poll, you shall have to deliver them, with zero delay, at such place (Receiving centres) as the Returning Officer may direct and in accordance with such arrangements as the Returning Officer may make. Any delay in this behalf will be viewed by the Commission with utmost concern and will invite severe disciplinary action against you.
- 7.6.2.2. You will hand over to the Official-in-charge of the Receiving Centre the following items of election records and materials and obtain a receipt:
 - a. Control Unit and, Ballot Unit(s) and VVPAT duly sealed in their respective carrying cases with VVPAT power pack.
 - b. First packet superscribed “EVM Papers” (containing 3 items)
 - c. Second packet superscribed “SCRUTINY COVER” (containing 4 items)
 - d. Third packet superscribed “STATUTORY COVERS” (containing 5 items)
 - e. Fourth packet superscribed “NON-STATUTORY COVERS” (containing 11 items)
 - f. Fifth packet superscribed as “HANDBOOK/MANUAL etc.” (containing 3+ items)
 - g. Sixth packet superscribed as “OTHER MATERIALS” (containing 5+ items)
 - h. All remaining stationery items should be placed back in the respective transparent Cardboard/Carton containers and submitted at the Receipt Center.
- 7.6.2.3. All the above items will be cleared by the receiving official(s) at the Receiving Centre in your presence and thereafter you will be relieved.

CHAPTER – 08

CORRUPT PRACTICES AND ELECTORAL OFFENCES

On the Poll Day, there may be case(s) where a person or a group of persons behave in disorderly manner at the Polling Station, these types of events come under the Electoral Offence(s). Some important aspects on the Electoral offences on Poll Day and related measures are mentioned in this Chapter.

8.1. PROHIBITION OF CANVASSING

8.1.1. The election law prohibits canvassing in or near polling stations on polling day. No person shall commit any of the following acts within a polling station or in any public or private place within a distance of 100 meters of a polling station, namely:

- (a) canvassing for votes;
- (b) soliciting the vote for any elector.
- (c) persuading any elector not to vote for any particular candidates;
- (d) persuading any elector not to vote at the election;
- (e) exhibiting any notice or sign (other than an official notice) relating to the election;
- (f) using or operating within or at the entrance of the polling station or in any public or private place in its neighbourhood any apparatus for amplifying or reproducing the human voice, such as megaphone or a loudspeaker; and
- (g) shouting or otherwise acting in a disorderly manner within or at the entrance of a polling station or in any public or private place in the neighbourhood.

N.B.- The distance from which a loudspeaker, etc, is used is immaterial. The offence will be committed even if it is used from a distance of more than 100 meters if it causes annoyance to any person visiting the polling station for the poll or interference with the work of officers and other person on duty at the polling station.

8.2. PREVENTION OF VOTERS FROM VOTING

8.2.1 It is cognizable offence to detain any voters in a camp or any other place whether with or without his consent or obstruct his way to Polling Station or to prevent him from voting in any manner. If the candidate receives information that any person is so detained or obstructed or prevented, he/she should report the matter to the Presiding Officer, or to the nearest Police Station or to the Returning Officer, who will take effective action to enable the person who are wrongly detained or obstructed or prevented to exercise their franchise even if the detention or obstruction is done in a private place.

8.3. ILLEGAL HIRING OF VEHICLES FOR THE CONVEYANCE OF VOTERS

8.3.1. If you are informed by a complainant about the conveyance of electors from their homes to the polling station by use of a means of transport on behalf of a contesting candidate, you must forward this complaint to the concerned Sub Divisional Magistrate through your Zonal/ Sector Magistrate.

8.4. REMOVAL OF VOTING MACHINE AND/OR OTHER POLLING MATERIALS FROM POLLING STATION TO BE AN OFFENCE

8.4.1. Any person, who at any election fraudulently or in an unauthorized way takes or attempts to take a voting machine out of a Polling Station or willfully aids or abets the doing of any such act, commits a cognizable offence punishable with imprisonment up to one year or with fine up to five hundred rupees or with both. In this connection Section 135 of the Representation of the People Act, 1951 read with Explanation to Section 61A of the said Act may be referred to.

8.4.2. In case of polling material other than the EVM is taken out or attempted to be taken out, the action is an offence under Section 135-A of Representation of People Act 1951.

8.4.3. In above circumstance or incident, you should handover him/her to the local Police Station having jurisdiction over the Polling Station with written information to the concerned Police Station in-charge.

8.5. REMOVAL OF DISORDERLY PERSONS

8.5.1. Any person, who misconducts himself or fails to obey lawful directions of the Presiding Officer during the poll, may be removed from the polling station under his order by any police officer or other persons authorised by him.

8.6. BREACH OF OFFICIAL DUTY BY ELECTION OFFICERS

8.6.1. Your attention is also drawn to Section 134 of the Representation of the People Act, 1951, which provides that if any Presiding or Polling Officer is guilty of any act, or even of any omission, in breach of his official duty without reasonable cause, he commits a cognizable offence.

8.7. PROHIBITION OF GOING ARMED TO OR NEAR A POLLING STATION

8.7.1. As per the provisions of Section 134B of the Representation of the People Act, 1951, no person (other than the Returning Officer, the Presiding Officer, any police officer and any other person appointed to maintain peace and order at a polling station who is on duty at the polling station) can, on a polling day, go armed with arms, as defined in the Arms Act, 1959, of any kind within the neighborhood of a polling station. If any person violates these provisions, he is liable to imprisonment for a term, which may extend to two years or with fine, or with both and the offence is cognizable.

8.8. CASE OF IMPERSONATION

8.8.1. The Commission has made documentary identification of electors as mandatory. The electors are required to produce the Electoral Photo Identity Card (EPIC) or other alternative document, if any, permitted by the Commission. The Commission will issue orders in this behalf at the time of every election. You must refer to the order issued by the Commission and enforce its compliance. The Polling Officer in-charge of identification must satisfy himself about the identity of the elector after examining the EPIC or the alternative documents, as the case may be, and in case of any doubt the elector should be directed to present himself before you. You should make a further probe to satisfy yourself about the identity of the elector. You should hand over the person to the police with a written complaint in case he is proved to be an impersonator.

8.9. OFFENCE OF BOOTH CAPTURING

8.9.1. Under Section 135A of the Representation of the People Act, 1951; Whosoever commits an offence of booth capturing shall be punishable with imprisonment for a term, which shall not be less than one year but which may extend to three years and with fine, and where such offence is committed by a person in the service of the Government, he shall be punishable with imprisonment for a term which shall not be less than three years but which may extend to five years and with fine. This offence punishable shall be cognizable.

8.9.2. "Booth capturing" includes, among other things, all or any of the following activities, namely:

8.9.2.1. Seizure of a polling station or a place fixed for the poll by any person or persons making polling authorities surrender the ballot papers or voting machines and doing of any other act which affects the orderly conduct of elections;

8.9.2.2. Taking possession of a polling station or a place fixed for the poll by any person or persons and allowing only his or their own supporters to exercise their right to vote and prevent others from free exercise of their right to vote;

8.9.2.3. Coercing or intimidating or threatening directly or indirectly any elector and preventing him from going to the polling station or a place fixed for the poll to cast his vote;

8.9.2.4. Seizure of a place for counting of votes by any person or persons, making the counting authorities surrender the ballot papers or voting machines and acting in a manner which affects the orderly counting of votes;

8.9.2.5. Doing by any person in the service of Government, of all or any of the aforesaid activities or aiding or conniving at, any such activity in the furtherance of the prospects of the election of a candidate.

Chapter 9

ACTIONABLE POINTS FOR PRESIDING OFFICERS/ POLLING OFFICERS AT A GLANCE

This chapter gives a summary of the handbook, which enables you to recapitulate your duty as a Presiding Officer. Maintain close relation with members of your polling party. Team work makes your task easier and enjoyable.

- 9.1 Ensure that:
 - 9.1.1. You have been supplied with the Control Unit and the requisite number of Ballot Units of the voting machine with VVPAT and the same are allotted to and meant to be used at your polling station; match Unit Ids written on address tag with the metallic plate/barcode on the back side of the unit.
 - 9.1.2. Appropriate ballot paper has been duly affixed and properly aligned on each Ballot Unit;
 - 9.1.3. Thumbwheels switch on each Ballot Unit has been set to appropriate position;
 - 9.1.4. ‘Candidate set section’ of the Control Unit and each Ballot Unit are duly sealed and address tags are firmly attached to each of them;
 - 9.1.5. Paper roll compartment of VVPAT is properly sealed with RO’s seal;
 - 9.1.6. Both the Control Unit and the Ballot Unit are duly sealed with the Pink Paper Seal (PPS) having the signature of representatives of political parties/candidates and engineers of manufacturing units;
 - 9.1.7. All the polling materials have been given to you.
- 9.2 Check particularly the Register of Voters, pre-printed voter’s slips, ballot papers to be used for tendered votes, arrow cross mark rubber stamp for marking tendered Votes, green paper seals, sealing wax, indelible ink, black envelope etc., half inch transparent cello tape etc.
- 9.3 Compare marked copy of electoral roll with other copies and see that all copies are identical and that marked copy of electoral roll contains no mark other than ‘PB’ and ‘EDC’.
- 9.4 Ensure:
 - 9.4.1 All pages of working copy of electoral roll are serially numbered;
 - 9.4.2 Printed serial numbers of voters are not corrected in ink and no new number substituted manually.
- 9.5 Set up Polling Station as per model layout as far as practicable.
- 9.6 Ensure separate entrance and exit for voters at Polling Station, if possible.
- 9.7 On the day of Poll, display all the 4(Four) posters including a notice specifying the polling area and copy of the list of contesting candidates outside your Polling Station.
- 9.8 Appoint a Polling Officer locally if any Polling Officer is absent due to any unforeseen exigency.
- 9.9 Start setting up of EVM and VVPAT for conduct of mock poll **90 minutes** before the hour fixed for the commencement of poll.
- 9.10 Before Mock Poll, place the Ballot Unit(s) and VVPAT in the Voting Compartment. Place the Control Unit on your table or on the table of Third Polling Officer, whosoever is given the charge of Control Unit, as the case may be.
- 9.11 Interlink Ballot Units, VVPAT and Control Unit. Put the power switch to ‘ON’ position in the rear compartment of Control Unit. Tape the connecting wires of BU and VVPAT to the leg of the table with “Transparent Adhesive Tape” of half inch width in such a manner that the wires do not hang in the air so that the load of hanging wire does not impact the connecting switch of the BU and VVPAT.
- 9.12 Secure the rear compartment of the Control Unit by tying a thin wire and giving it a few twists or with the help of a twine thread and tying a knot. **DO NOT SEAL IT WITH WAX.**

- 9.13 Show to all the Polling Agents, who are present at the Polling Station, that the voting machine and VVPAT is clear and no vote is already recorded therein.
- 9.14 Conduct a mock poll with the help of Polling Officers and contesting candidates/Polling Agents to record at least 50 votes comprising votes for each of the candidates including NOTA. After Mock poll, ascertain the result in the CU, count the VVPAT paper slips in the presence of the Polling Agents and confirm that the results tally for each candidate.
- 9.15 Clear the mock poll data in CU by pressing ‘CLEAR’ button and remove VVPAT paper slips from VVPAT drop box and show the empty drop box of VVPAT to the Polling Agents. Seal the mock poll VVPAT paper slips in the black envelope after stamping ‘mock poll slip’ on its backside. Seal the envelope with the seal and put your signature and of Polling Agents on envelope. Write the number and name of the Polling Station, number and name of Assembly Constituency, date of poll and the words ‘VVPAT paper slips of Mock Poll’ on the envelope. Seal it with pink paper slip in such manner that opening of box will require breaking of seal. Put your signature and of Polling Agents on the pink paper seal and keep the envelope along with other documents relating to election.
- 9.16 Fix green paper seal in the frame on the door of the inner compartment of result section of Control Unit.
- 9.17 Close the door of the inner compartment of result section in such a way that the two open ends of the paper seal project outwards from the sides of the inner compartment.
- 9.18 Put your full signature on the green paper seal below the printed serial number.
- 9.19 Obtain the signatures of Polling Agents, who are present at the Polling Station and are desirous of putting their signatures on the paper seal. Allow them to note the serial number of paper seal.
- 9.20 Seal the door of the inner compartment of result section of the Control Unit with special tag.
- 9.21 Close the outer cover of result section of the Control Unit and seal it with an address tag and the self-adhesive ends of the green paper seal protruding from the outer cover of the result section.
- 9.22 Allow the Polling Agents also to affix their seals on the outer cover of result section of Control Unit. Secure and seal the drop box of VVPAT with Address Tags.
- 9.23 The interconnecting cable should be so routed that it does not obstruct the movement for voters inside the Polling Station and they don’t tread or trip over it, but the entire length of the cable should be visible and under no circumstances be concealed under the cloth or under the table.
- 9.24 Demonstrate to the Polling Agents present that the marked copy of the electoral roll does not contain any entries other than PB and EDC.
- 9.25 Demonstrate also that the Register of Voters (Form 17A) does not contain any entry beforehand.
- 9.26 Read out the declaration and sign it before the commencement of poll.
- 9.27 Commence the poll at the appointed hour positively. Before the first voter signs in Form 17A (Register of Voters), the Polling Officer -1 shall check with the Presiding Officer and record in INK in Form 17A that “Total in the Control Unit has been checked and found to be Zero”.
- 9.28 Warn every one, who is present at the Polling Station, to maintain absolute secrecy of voting by reading out aloud section 128 of the Representation of the People Act, 1951.
- 9.29 Allow only one polling agent of a contesting candidate inside the Polling Station at any given time.
- 9.30 Ensure free and fair poll.
- 9.31 Show due courtesy and regard to the Observer appointed by the Commission and furnish all the information required by him. Show the same courtesy and regard to the Micro Observer present at your Polling Station.
- 9.32 Canvassing within one hundred meters of the Polling Station is an offence. Use of mobile phone within the Polling Station is prohibited. You, as Presiding Officer, or your first polling officer can use it only for sending reports through SMS/ WhatsApp.
- 9.33 Smoking inside Polling Station is strictly prohibited.

- 9.34 Do not give any special treatment to any VIP or celebrity coming to cast vote.
- 9.35 The duties of Polling Officers, where there are one Presiding Officer and three Polling Officers, are as under: The first Polling Officer will have the marked copy of the electoral roll and will be responsible for identifying the electors. The printing and clerical mistakes in the roll will be overlooked by him. The second Polling Officer will have the indelible ink and the Register of Voters with him. He will apply indelible ink on the index finger of the elector, enter the serial number of the elector on the Register of Voters in Column (2) of the register and write down the name of the identification document. He will then obtain the signature/thumb impression of the voter before issuing the voter's slip to the elector. The third Polling Officer will be in-charge of the Control Unit. He will take the voter's slip from the elector, check the indelible ink mark on his left-hand index finger and finally press the 'Ballot' button on Control Unit to make the Ballot Unit kept inside the Voting Compartment ready and direct the elector to go inside the Voting Compartment and cast his vote by pressing the blue button of his choice on the Ballot Unit.
- 9.36 Duties of Polling Officers at simultaneous elections, when the polling party consists of one Presiding Officer and five Polling Officers, are as under: The first Polling Officer will be responsible for identifying the electors and will be in-charge of marked copy of the electoral roll. The second Polling Officer will be in-charge of the indelible ink and Register of Voters. The third Polling Officer will be in-charge of the Voter's Slip. The fourth Polling Officer will be in charge of the Control Unit for Lok Sabha Election. The fifth Polling Officer will be in-charge of the Control Unit for State Assembly election.
- 9.37 Allow the electors to record their votes exactly in the same order in which they have been entered in the Register of Voters. Do not allow them to vote unless they have signed/affixed their thumb impression on the Register of Voters.
- 9.38 Do not entertain any challenge to the identity of an elector unless the challenger pays challenge fee of two rupees in cash. Maintain record of such challenged votes in Form 14. If the challenge is established, hand over the person to the police with a complaint in writing.
- 9.39 In the cases of blind and infirm electors, obtain the required declaration from the companion of such blind and infirm electors. Also maintain a record of such voters in Form 14A.
- 9.40 If you consider an elector to be much below the voting age, i.e. 18 years but are otherwise satisfied about his identity, obtain a declaration from him about his age. Do not question his eligibility.
- 9.41 Do not force or compel an elector to vote if he decides not to vote after his particulars have been noted in the Register of Voters. Make an entry to that effect in the 'Remarks' column against the entry relating to that elector in the Register.
- 9.42 Do not change any serial number in column 1 of the register because of any elector who decides not to vote.
- 9.43 Allow an elector to vote only by means of tendered ballot paper if he turns up at the polling station after someone else has already voted in his name and you are satisfied about his identity. Do not allow him to record his vote in the voting machine.
- 9.44 Maintain a record of such electors to whom tendered ballot papers have been issued. Such record shall be maintained in Form 17B. Keep the tendered ballot papers and list in Form 17B in a separate cover.
- 9.45 Do not allow an elector to vote if he refuses to follow the prescribed voting procedure to maintain secrecy of voting after being warned by you.
- 9.46 Make an entry to that effect in the 'Remarks' column against the entry relating to him in the Register of Voters. Do not change any serial numbers in column 1 of that register because of such elector.
- 9.47 In order to ensure that all the electors, who are standing in queue at the hour appointed for closing the poll, are able to cast their vote, distribute serially numbered slips duly signed by you to all electors standing in queue a few minutes before closing hour of poll, starting the operation from the end of the queue.
- 9.48 Allow all persons, to whom such slips have been issued, to vote even if the poll has to be continued for some time beyond the appointed closing hour.

- 9.49 Press TOTAL button to tally with number of votes in Form 17A (Register of Voters) and note down the number of votes recorded in Control Unit.
- 9.50 Formally announce the close of poll after the last elector has voted.
- 9.51 Close the voting machine by removing the rubber cap covering the 'CLOSE' button and pressing the 'Close' button on the Control Unit. Replace the rubber cap over the 'Close' button after it has been so pressed. Prepare **Part-III of the Presiding Officer's Report (Annexure-5)**
- 9.52 After the close of poll, put the power switch 'Off' in the rear compartment of Control Unit and disconnect the Ballot Unit(s), VVPAT and Control Unit.
- 9.53 Presiding Officer will remove Power Pack (battery) from VVPAT in the presence of Polling Agents. Only after removal of Power Pack (VVPAT), seal the carrying case of VVPAT in the presence of Polling Agents (ECI Instructions dated 9th April, 2019- Instructions on use of Power Pack (Battery) in VVPATs-regarding)
- 9.54 Keep the Control Unit, VVPAT and Ballot Unit(s) in their respective carrying cases.
- 9.55 Seal the carrying cases on both ends, by firmly attaching address tags to each carrying case.
- 9.56 Prepare the account of votes recorded in Form 17C.
- 9.57 Give the attested copies of the account of votes recorded to each of the contesting candidates/polling agents. Make declaration to that effect in the prescribed declaration Form.
- 9.58 Allow all contesting candidates/polling agents, who are present at the polling station and willing to do so, to affix their seals on these carrying cases.
- 9.59 Seal all election papers and materials in separate packets.
- 9.60 Affix your seal on the covers containing (1) marked copy of electoral roll, (2) Register of Voters, (3) voter's slips, (4) used tendered ballot papers and list in Form 17B, and (5) unused tendered ballot papers.
- 9.61 Allow all contesting candidates/polling agents to affix their seals on these covers also, if they so desire.
- 9.62 Keep all packets of election papers and materials in the respective packets. Refer to Chapter 7 for packing of material.
- 9.63 You shall not be relieved of duty unless you submit all the election related papers and material at the Receipt Centre.
- 9.64 Deliver the voting machine with VVPAT, and all other election material at the collection centre promptly after the poll, without any delay.
- 9.65 In order to keep complete and accurate account of events at the polling station, maintain the Presiding Officer's diary properly in all respects. Complete the entries therein as and when any event takes place and not at the end of poll.
- 9.66 If open violence or riot takes place at the polling station, adjourn the poll. Report the full facts to the Returning Officer forthwith.
- 9.67 If there is booth capturing or any voting machine or election material like Register of Voters, marked copy of the electoral roll, etc. taken away in unauthorized way from your custody or damaged or tampered with, close the poll. Report the full facts to the Returning Officer forthwith.
- 9.68. **Replacement of EVM & VVPAT**
- (a) If any of the units found defective before start of the actual poll only the defective unit(s) will be replaced and mock poll will be completed with the new unit(s). Part-IV of the Presiding Officer's Report will be prepared and given to SO.
 - (b) Part-I of the Presiding Officer's Report will be prepared after every mock poll.
 - (c) If CU power pack is changed during actual poll, Part-II of the Presiding Officer's Report will be prepared, no mock poll is required in this case.

- (d) If VVPAT or VVPAT and power pack is found defective during actual poll, only the VVPAT or the VVPAT power pack will be changed, no mock poll is required in this case. Part-V of the Presiding Officer’s Report will be prepared and given to SO.
- (e) If BU or CU is found defective during actual poll, complete set of BU+CU+VVPAT will be changed. Mock poll by casting one vote to all candidate including NOTA will be done with the new set. Part-I and Part-V of the Presiding Officer’s Report will be prepared and Part-V will be given to SO.

9.A: COMMON MISTAKES

Common Mistakes other than EVM/VVPAT operation by Presiding Officers
<ul style="list-style-type: none"> • CRC was not done after mock poll. • Mock poll slips were not removed • After poll has ended, forgot to press “CLOSE” button • Even when only VVPAT is replaced, mock poll was done which was not permitted. • Did not submit 17C. Some submitted with incomplete details • Voter turnout report was not properly given. Total electors assigned to the polling station was mentioned instead of total votes polled. Male and Female voters’ figures were not given. • EVMs, VVPATs were replaced unnecessarily, for e.g. connections were not made properly, but still EVMs were replaced. • Address tags for carry cases of EVM, VVPAT were not tied and sealed at the end of poll.

9.B: DOs AND DON’Ts

9.B.1. DOs AND DON’Ts ON USE OF VVPAT

Dos	DON’S
Ensure paper roll knob is locked (horizontal position) before transportation.	
In Polling Station, unlock the paper roll knob (vertical position), before switching ON the CU.	Don’ switch ON CU before VVPAT paper roll knob is in unlocked condition (vertical position).
Position BU and VVPAT in Voting Compartment. Position CU on PO’ Table	
Establish right connection by following the color scheme	Don’ allow direct light or high power illumination over VVPAT.
Ensure the connectors are inserted properly.	Don’ remove cables without pressing the clips on the connectors.
Switch ‘N’ CU, the Power On Green LED on VVPAT glows and VVPAT prints all 7 slips.	Don’ switch OFF CU unless all 7 slips are printed and cut.
Check for any “RROR” message on CU. Inform Sector Officer (SO) in case of any “RROR”	Don’ start polling in case of “RINTER ERROR” message on CU.

Always switch OFF CU before making any connection or disconnection including change of battery.	Don't operate the paper roll knob till the end of the poll.
---	---

NOTE:

VVPAT related messages are displayed on the CU's Display.

9.B.2. DOS AND DON'TS OTHER THAN VVPAT

Dos	DON'S
Attend all trainings	Don't leave the polling material to the custody of Police or others.
Read all material given	Don't allow agents to bring phones or cameras to PS or any electronic gadgets.
Have hands on experience with EVMs	Don't allow voters also to come into PS with phones cameras or any electronic gadgets.
Use Postal Ballot facility / EDC	Don't allow arguments with polling staff.
Verify material carefully at distribution centre	Don't allow anyone to light fire in the PS.
Stay in the Polling Station on the night before poll.	Don't allow any agent to canvass in the PS.
Cover or remove photographs of political leaders in the PS.	Don't allow anyone to enter the PS with any publicity material or outfit.
Start and complete the pre poll process as per schedule	Don't allow press photographers to take photographs
Work as team and be cooperative.	Don't get into argument.
Be impartial and also appear to be impartial.	Don't discuss with agents about the result or voting trends.
Verify if the polling agent is a voter in the PS.	Don't allow candidates or Election Agents to enter the PS with gunmen or supporters.
Allow Polling agents present to sign on the seals	Don't allow visiting candidates or Election Agents to disturb the election process.
Perform CRC on the CU before sealing.	Don't allow police to enter PS unless called.
Maintain visitor sheet	Don't allow unauthorized persons to enter Polling Station including ministers.
Supply copies of FORM 17C to all polling agents	Don't allow anyone to go to the voting compartment while the voter is casting his vote.
Fill up PrO' diary meticulously.	Don't allow agent to be a companion.
PO to attend the authorized visitors and allow the poll process to continue.	Don't allow anyone to join the queue after the appointed hours for closing the poll.
Close the poll at the scheduled hour and follow the procedure.	Don't be in hurry. Hasty work leads to error.

SECTION – II

Annexures

ANNEXURE - 1

EXTRACTS FROM THE REPRESENTATION OF THE PEOPLE ACT, 1951

[Chapter – 1, Para 1.1]

Note:- All points mentioned in Annexure-1 (Extracts From The Representation of The People Act, 1951) and Annexure-2 (Extracts From The Conduct Of Elections Rules, 1961) may be read in terms of explanation to Section 61A regarding any change have been made due to inclusion of EVM machine and VVPAT.”

26. Appointment of Presiding Officer for Polling Stations

- (1) The District Election Officer shall appoint a Presiding Officer for each Polling Station and such Polling Officer or Officers as he thinks necessary, but he shall not appoint any person who has been employed by or on behalf of, or has been otherwise working for, a candidate in or about the election.

Provided that if a Polling Officer is absent from the Polling Station, the Presiding Officer may appoint any person who is present at the Polling Station other than a person who has been employed by or on behalf of, or has been otherwise working for, a candidate in or about the election, to be the Polling Officer during the absence of the former officer, and inform the District Election Officer accordingly.

Provided further that nothing in this sub-section shall prevent that District Election Officer from appointing the same person to be the Presiding Officer for more than one Polling Station in the same premises.

- (2) A Polling Officer shall, if so directed by the Presiding Officer, perform all or any of the functions of a Presiding Officer under this Act or any rules or orders made thereunder.
- (3) If the Presiding Officer, owing to illness or other unavoidable cause, is obliged to absent himself from the polling station, his functions shall be performed by such Polling Officer as has been previously authorised by the District Election Officer to perform such functions during any such absence.
- (4) References in this Act to the Presiding Officer shall, unless the context otherwise requires, be deemed to include any person performing any function which he is authorised to perform under sub-section (2) or sub-section (3), as the case may be.

27. General duty of the Presiding Officer: –

It shall be the general duty of the Presiding Officer at a polling station to keep order thereat and to see that the poll is fairly taken.

28. Duties of a Polling Officer

It shall be the duty of the Polling Officers at a polling station to assist the Presiding Officer for such station in the performance of his functions.

28A. The Returning Officers, Presiding Officers, etc., deemed to be on deputation to Election Commission

The Returning Officer, Assistant Returning Officer, Presiding Officer, Polling Officer and any other Officer appointed under this Part and any police officer designated for the time being by the State Government, for the conduct of any election shall be deemed to be on deputation to the Election Commission for the period commencing on and from the date of the Notification calling for such election and ending with the date of declaration of the results of such election and accordingly such officers shall during that period be subject to the control superintendence and discipline of the Election Commission.

46. Appointment of Polling Agents

A contesting candidate or his Election Agent may appoint in the prescribed manner such number of agents and reliever agent as may be prescribed to act as Polling Agents of such candidate at each Polling Station provided under section 25 or at the place fixed under sub-section (1) of section 29 for the poll.

48. Revocation of the appointment or death of a polling agent or counting agent

- (1) Any revocation of the appointment of a polling agent shall be signed by the candidate or his election agent and shall operate from the date on which it is lodged with such officer as may be prescribed, and in the event of such a revocation or of the death of a polling agent before the close of the poll, the candidate or his election agent may appoint in the prescribed manner another polling agent at any time before the poll is closed and shall forthwith give notice of such appointment in the prescribed manner to such officer as may be prescribed.
- (2) Any revocation of the appointment of a counting agent shall be signed by the candidate or his election agent and shall operate from the date on which it is lodged with the Returning Officer, and in the event of such a revocation or of the death of a counting agent before the commencement of the counting of votes, the candidate or his election agent may appoint in the prescribed manner another counting agent at any time before the counting of votes is commenced and shall forthwith give notice of such appointment in the prescribed manner to the Returning Officer.

49. Functions of Polling Agents and counting agents

- (1) A polling agent may perform such functions in connection with the poll as are authorised by or under this Act, to be performed by a polling agent.
- (2) A counting agent may perform such functions in connection with the counting of votes as are authorised by or under this Act to be performed by a counting agent.

50. Attendance of a contesting candidate or his election agent at polling stations and performance by him of the functions of a polling agent or counting agent

- (1) At every election where a poll is taken, each contesting candidate at such election and his election agent shall have a right to be present at any polling station provided under section 25 for the taking of the poll or at the place fixed under sub-section (1) of section 29 for the poll.
- (2) A contesting candidate or his election agent may himself do any act or thing which any polling agent or the counting agent of such contesting candidate, if appointed, would have been authorized by or under this Act to do, or may assist any polling agent or the counting agent of such contesting candidate in doing any such act or thing.

51. Non-attendance of polling or counting agents

Where any act or thing is required or authorised by or under this Act to be done in the presence of the polling or counting agents, the non-attendance of any such agent or agents at the time and place appointed for the purpose shall not, if the act or thing is otherwise duly done, invalidate the act or thing done.

57. Adjournment of poll in emergencies

- (1) If at an election the proceedings at any polling station provided under section 25 or at the place fixed under sub-section (1) of section 29 for the poll are interrupted or obstructed by any riot or open violence, or if at an election it is not possible to take the poll at any polling station or such place on account of any natural calamity, or any other sufficient cause, the Presiding Officer for such polling station or the Returning Officer presiding over such place, as the case may be, shall announce an adjournment of the poll to a date to be notified later, and where the poll is so adjourned by a Presiding Officer, he shall forthwith inform the Returning Officer concerned.
- (2) Whenever a poll is adjourned under sub-section (1), the Returning Officer shall immediately report the circumstances to the appropriate authority and the Election Commission, and shall, as soon as may be, with the previous approval of the Election Commission, appoint the day on which the poll shall recommence, and fix the polling station or place at which and the hours during which the poll will be taken and shall not count the votes cast at such election until such adjourned poll shall have been completed.
- (3) In every such case as aforesaid; the Returning Officer shall notify in such manner as the Election Commission may direct the date, place and hours of polling fixed under sub-section (2)

61A. Voting Machines at Elections

Notwithstanding anything contained in this Act or the rules made thereunder, the giving and recording of votes by voting machines in such manner as may be prescribed, may be adopted in such constituency or constituencies as the Election Commission may, having regard to the circumstances of each case, specify.

Explanation. – For the purpose of this section, “Voting Machine” means any machine or apparatus whether operated electronically or otherwise used for giving or recording of votes and any reference to a ballot box or ballot paper in this Act or the rules made thereunder shall, save as otherwise provided, be construed as including a reference to such voting machine wherever such voting machine is used at any election.

62. Right to vote

- (1) No person who is not, and except as expressly provided by this Act, every person who is, for the time being entered in the electoral roll of any constituency shall be entitled to vote in that constituency.
- (2) No person shall vote at an election in any constituency if he is subject to any of the disqualifications referred to in section 16 of the Representation of the People Act, 1950 (43 of 1950).
- (3) No person shall vote at a general election in more than one constituency of the same class, and if a person votes in more than one such constituency, his votes in all such constituencies shall be void.
- (4) No person shall at any election vote in the same constituency more than once, notwithstanding that his name may have been registered in the electoral roll for that constituency more than once, and if he does so vote, all his votes in that constituency shall be void.
- (5) No person shall vote at any election if he is confined in a prison, whether under a sentence of imprisonment or transportation or otherwise, or is in the lawful custody of the police:

Provided that nothing in this sub-section shall apply to a person subjected to preventive detention under any law for the time being in force.

Provided further that by reason of the prohibition to vote under this sub-section, a person whose name has been entered in the electoral roll shall not cease to be an elector.

- (6) Nothing contained in sub-sections (3) and (4) shall apply to a person who has been authorised to vote as proxy for an elector under this Act in so far as he votes as a proxy for such elector.

128. Maintenance of secrecy of voting

- (1) Every officer, clerk, agent or other person who performs any duty in connection with the recording or counting of votes at an election shall maintain, and aid in maintaining, the secrecy of the voting and shall not (except for some purpose authorised by or under any law) communicate to any person any information calculated to violate such secrecy.

Provided that the provisions of this sub-section shall not apply to such officer, clerk, agent or other person who performs any such duty at an election to fill a seat or seats in the Council of States.

- (2) Any person who contravenes the provisions of sub section (1) shall be punishable with imprisonment for a term which may extend to three months or with fine or with both.

129. Officers, etc., at elections not to act for candidates or to influence voting

- (1) No person who is a District Election Officer or a Returning Officer, or an Assistant Returning Officer, or a Presiding or Polling Officer at an election, or an officer or clerk appointed by the Returning Officer or the Presiding Officer to perform any duty in connection with an election shall in the conduct or the management of the election do any act (other than the giving of vote) for the furtherance of the prospects of the election of a candidate.
- (2) No such person as aforesaid, and no member of a police force, shall endeavour—

- (a) to persuade any person to give his vote at an election, or
 - (b) to dissuade any person from giving his vote at an election, or
 - (c) to influence the voting of any person at an election in any manner.
- (3) Any person who contravenes the provisions of sub-section (1) or sub-section (2) shall be punishable with imprisonment which may extend to six months or with fine or with both.
- (4) An offence punishable under sub-section (3) shall be cognizable.

130. Prohibition of canvassing in or near polling station

- (1) No person shall, on the date or dates on which a poll is taken at any polling station, commit any of the following acts within the polling station or in any public or private place within a distance of one hundred metres of the polling station, namely: –
- (a) canvassing for votes; or
 - (b) soliciting the vote of any elector; or
 - (c) persuading any elector not to vote for any particular candidate; or
 - (d) persuading any elector not to vote at the election; or
 - (e) exhibiting any notice or sign (other than an official notice) relating to the election.
- (2) Any person who contravenes the provisions of sub-section (1) shall be punishable with fine which may extend to two hundred and fifty rupees.
- (3) An offence punishable under this section shall be cognizable.

131. Penalty for disorderly conduct in or near polling stations

- (1) No person shall, on the date or dates on which a poll is taken at any polling station, –
- (a) use or operate within or at the entrance of the polling station, or in any public or private place in the neighbourhood thereof, any apparatus for amplifying or reproducing the human voice, such as a megaphone or a loud-speaker, or
 - (b) shout, or otherwise act in a disorderly manner, within or at the entrance of the polling station or in any public or private place in the neighbourhood thereof, so as to cause annoyance to any person visiting the polling station for the poll, or so as to interfere with the work of the officers and other persons on duty at the polling station.
- (2) Any person who contravenes, or wilfully aids or abets the contravention of the provisions of sub-section (1) shall be punishable with imprisonment which may extend to three months or with fine or with both.
- (3) If the Presiding Officer of a polling station has reason to believe that any person is committing or has committed an offence punishable under this section, he may direct any police officer to arrest such person, and thereupon the police officer shall arrest him.
- (4) Any police officer may take such steps, and use such force as may be reasonably necessary for preventing any contravention of the provisions of sub-section (1), and may seize any apparatus used for such contravention.

132. Penalty for misconduct at the polling station

- (1) Any person who during the hours fixed for the poll at any Polling Station misconducts himself or fails to obey the lawful directions of the Presiding Officer may be removed from the Polling Station by the Presiding Officer or by any police officer on duty or by any person authorised in this behalf by such Presiding Officer.
- (2) The powers conferred by sub-section (1) shall not be exercised so as to prevent any elector who is otherwise entitled to vote at a Polling Station from having an opportunity of voting at that station.
- (3) If any person who has been so removed from a Polling Station re-enters the Polling Station without the permission of the Presiding Officer, he shall be punishable with imprisonment for a term which may extend to three months, or with fine, or with both.
- (4) An offence punishable under sub-section (3) shall be cognizable.

132A. Penalty for failure to observe procedure for voting

If any elector to whom a ballot paper has been issued, refuses to observe the procedure prescribed for voting the ballot paper issued to him shall be liable for cancellation.

133. Penalty for illegal hiring or procuring of conveyance at elections

If any person is guilty of any such corrupt practice as is specified in clause (5) of section 123 at or in connection with an election, he shall be punishable with imprisonment which may extend to three months and with fine.

134. Breaches of official duty in connection with elections

- (1) If any person to whom this section applies is without reasonable cause guilty of any act or commission in breach of his official duty, he shall be punishable with fine which may extend to five hundred rupees.
(1A) An offence punishable under sub-section (1) shall be cognizable.
- (2) No suit or other legal proceedings shall lie against any such person for damages in respect of any such act or omission as aforesaid.
- (3) The person to whom this section applies are the District Election Officers, Returning Officers, Assistant Returning Officers, Presiding Officers, Polling Officers and any other person appointed to perform any duty in connection with the receipt of nominations or withdrawal of candidatures, or the recording or counting of votes at an election; and the expression “official duty” shall for the purpose of this section be construed accordingly, but shall not include duties imposed otherwise than by or under this Act.

134A. Penalty for government servants for acting as election agent, polling agent or counting agent

If any person in the service of the Government acts as an Election Agent or a Polling Agent or a Counting Agent of a candidate at an election, he shall be punishable with imprisonment for a term which may extend to three months, or with fine, or with both.

134B. Prohibition of going armed to or near a polling station

- (1) No person, other than the Returning Officer, the Presiding Officer, any police officer and any other person appointed to maintain peace and order at a polling station who is on duty at the polling station, shall, on a polling day, go armed with arms, as defined in the Arms Act, 1959 (54 of 1959), of any kind within the neighbourhood of a polling station.
- (2) If any person contravenes the provisions of sub-section (1), he shall be punishable with imprisonment for a term which may extend to two years, or with fine, or with both.
- (3) Notwithstanding anything contained in the Arms Act, 1959 (54 of 1959), where a person is convicted of an offence under this section, the arms as defined in the said Act found in his possession shall be liable to confiscation and the license granted in relation to such arms shall be deemed to have been revoked under section 17 of that Act.
- (4) An offence punishable under sub-section (2) shall be cognizable.

135. Removal of ballot papers from polling station to be an offence

- (1) Any person who at any election unauthorisedly takes, or attempts to take, a ballot paper out of a polling station, or wilfully aids or abets the doing of any such act, shall be punishable with imprisonment for a term which may extend to one year or with fine which may extend to five hundred rupees or with both.
- (2) If the Presiding Officer of a polling station has reason to believe that any person is committing or has committed an offence punishable under sub-section (1), such officer may, before such person leaves the polling station, arrest or direct a police officer to arrest such person and may search such person or cause him to be searched by a police officer:

Provided that when it is necessary to cause a woman to be searched, the search shall be made by another woman with strict regard to decency.

- (3) Any ballot paper found upon the person arrested on search shall be made over for safe custody to a police officer by the Presiding Officer, or when the search is made by a police officer, shall be kept by such officer in safe custody.
- (4) An offence punishable under sub-section (1) shall be cognizable.

135A. Offence of booth capturing

- (1) Whoever commits an offence of booth capturing shall be punishable with imprisonment for a term which shall not be less than one year but which may extend to three years and with fine, and where such offence is committed by a person in the service of the Government, he shall be punishable with imprisonment for a term which shall not be less than three years but which may extend to five years and with fine.

Explanation—For the purposes of this sub-section and section 20B, “booth capturing” includes, among other things, all or any of the following activities namely: –

- (a) seizure of a polling station or a place fixed for the poll by any person or persons, making polling authorities surrender the ballot papers or voting machines and doing of any other act which affects the orderly conduct of elections;
 - (b) taking possession of a polling station or a place fixed for the poll by any person or persons and allowing only his or their own supporters to exercise their right to vote and prevent others from free exercise of their right to vote;
 - (c) coercing or intimidating or threatening directly or indirectly any elector and preventing him from going to the polling station or a place fixed for the poll to cast his vote;
 - (d) seizure of a place for counting of votes by any person or persons, making the counting authorities surrender the ballot papers or voting machine and doing of anything which affects the orderly counting of votes;
 - (e) doing by any persons in the service of Government, of all or any of the aforesaid activities or aiding or conniving at any such activity in the furtherance of the prospects of the election of a candidate.
- (2) An offence punishable under sub-section (1) shall be cognizable.

136. Other offences and penalties therefore

- (1) A person shall be guilty of an electoral offence if at any election he—
 - (a) fraudulently defaces or fraudulently destroys any nomination paper; or
 - (b) fraudulently defaces, destroys or removes any list, notice or other document affixed by or under the authority of a Returning Officer; or
 - (c) fraudulently defaces or fraudulently destroys any ballot paper or the official mark on any ballot paper or any declaration of identity or official envelope used in connection with voting by postal ballot; or
 - (d) without due authority supplies any ballot paper to any person, or receives any ballot paper from any person or is in possession of any ballot paper; or
 - (e) fraudulently puts into any ballot box anything other than the ballot paper which he is authorised by law to put in; or
 - (f) without due authority destroys, takes, opens or otherwise interferes with any ballot box or ballot papers then in use for the purpose of the election; or
 - (g) fraudulently or without due authority, as the case may be, attempts to do any of the foregoing acts or wilfully aids or abets the doing of any such acts.
- (2) Any person guilty of an electoral offence under this section shall, –

- (a) if he is a Returning Officer or an Assistant Returning Officer or a Presiding Officer at a polling station or any other officer or clerk employed on official duty in connection with the election, be punishable with imprisonment for a term which may extend to two years or with fine or with both;
 - (b) if he is any other person, be punishable with imprisonment for a term which may extend to six months or with fine or with both.
- (3) For the purposes of this section, a person shall be deemed to be on official duty if his duty is to take part in the conduct of an election or part of an election including the counting of votes or to be responsible after an election for the used ballot papers and other documents in connection with such election, but the expression “official duty” shall not include any duty imposed otherwise than by or under this Act.
- (4) An offence punishable under sub-section (2) shall be cognizable.

ANNEXURE - 2
EXTRACTS FROM THE CONDUCT OF ELECTIONS RULES, 1961
(CHAPTER – 1, Para1.1)

Note:- All points mentioned in Annexure-1 (Extracts From The Representation Of The People Act, 1951) and Annexure-2 (Extracts From The Conduct Of Elections Rules, 1961) may be read in terms of explanation to Section 61A regarding any change have been made due to inclusion of EVM machine and VVPAT.”

13. Appointments of Polling Agents

- (1) The number of Polling Agents that may be appointed under section 46 shall be one agent and two reliever agent.
- (2) Every such appointment shall be made in Form 10 and shall be made over to the Polling Agent for production at the Polling Station or the place fixed for the poll, as the case may be.
- (3) No polling agent shall be admitted into the Polling Station or the place fixed for the poll unless he has delivered to the Presiding Officer the instrument of his appointment under sub-rule (2) after duly completing and signing before the Presiding Officer the declaration contained therein.

14. Revocation of the appointment of polling agent

- (1) The revocation of the appointment of a Polling Agent under sub-section (1) of section 48 shall be made in Form 11 and lodged with the Presiding Officer.
- (2) In the event of any such revocation the candidate or his Election Agent may, at any time before the poll is closed, make a fresh appointment in the manner specified in rule 13 and the provisions of that rule shall apply to every such agent.

16. Voting normally to be in person: —

Save as hereinafter provided, all electors voting at an election shall do so in person at the polling station provided for them under section 25 or, as the case may be, at the place of polling fixed under section 29.

POSTAL BALLOT

17. Definitions: – In this part–

- (a) “service voter” means any person specified in clause (a) or clause (b) of section 60, but does not include “classified service voter” defined in rule 27M;
- (b) “special voter” means any person holding an office to which the provisions of sub-section (4) of section 20 of the Representation of the People Act, 1950 are declared to apply or the wife of such person, if he or she has been registered as an elector by virtue of a statement made under sub-section (5) of the said section;
- (c) “voter on election duty” means any Polling Agent, any Polling Officer, Presiding Officer or other public servant, who is an elector in the constituency and is by reason of his being on election duty unable to vote at the polling station where he is entitled to vote.

18. Persons entitled to vote by post

The following persons shall, subject to their fulfilling the requirements hereinafter specified, be entitled to vote by post, namely–

- (a) at an election in a Parliamentary or Assembly constituency–
 - (i) special voters;
 - (ii) service voters;
 - (iii) voters on election duty; and
 - (iv) electors subjected to preventive detention;

- (v) Following categories of Absentee voters, in pursuance of the Conduct of Elections (Amendment) Rules, 2019, and the Conduct of Elections (Amendment) Rules, 2020 read with the Election Commission's decision dated 16th July, 2020 have been given the facility of voting through postal ballot (PB) paper:
 - ▶ Senior citizens (above 80 years of age),
 - ▶ Persons with disability flagged in the electoral roll and
 - ▶ COVID 19 suspect or affected persons.
- (b) at an election in a Council constituency –
 - (i) voters on election duty;
 - (ii) electors subjected to preventive detention; and
 - (iii) electors in the whole or any specified parts of the constituency if directed by the Election Commission in this behalf under clause (b) of rule 68;
- (c) at an election by assembly members –
 - (i) electors subjected to preventive detention; and
 - (ii) all electors if directed by the Election Commission in this behalf under clause (a) of rule 68.

20. Intimation by voters on election duty

- (1) A voter on election duty who wishes to vote by post at an election shall send an application in Form 12 to the Returning Officer so as to reach him at least seven days or such shorter period as the Returning Officer may allow before the date of poll; and if the Returning Officer is satisfied that the applicant is a voter on election duty, he shall issue a postal ballot paper to him.
- (2) Where such voter, being a Polling Officer, Presiding Officer or other public servant on election duty in the constituency of which he is an elector, wishes to vote in person at an election in a Parliamentary or Assembly constituency and not by post, he shall send an application in Form 12A to the Returning Officer so as to reach him at least four days, or such shorter period as the Returning Officer may allow, before the date of poll; and if the Returning Officer is satisfied that the applicant is such public servant and voter on election duty in the constituency, he shall–
 - (a) issue to the applicant an election duty certificate in Form 12B;
 - (b) mark 'EDC' against his name in the marked copy of the electoral roll to indicate that an election duty certificate has been issued to him; and
 - (c) ensure that he is not allowed to vote at the polling station where he would otherwise have been entitled to vote.

MINISTRY OF LAW JUSTICE & COMPANY AFFAIRS (LEGISLATIVE DEPARTMENT) NOTIFICATION

NEW DELHI, THE 24TH MARCH, 1992

S.O. 230(E)— In exercise of the powers conferred by section 169 of the Representation of the People Act, 1951 (43 of 1951), the Central Government after consulting the Election Commission, hereby makes the following rules further to amend the Conduct of Election Rules, 1961 namely: –

1. (i) These rules may be called the Conduct of Elections (Amendment) Rules, 1992.
(ii) They shall come into force on the date of their publication in the Official Gazette.
2. In the Conduct of Election Rules, 1961 (herein after referred to as the principal rules)
 - (a) after the heading to Part IV, the following shall be inserted, namely: –
“Chapter I Voting by ballot”;
 - (b) in rule 28, for the words “In this Part”, the words “In this Chapter and Chapter II” shall be substituted;
 - (c) after rule 49, the following shall be inserted namely: –

49C. Arrangements at the Polling Stations

- (1) Outside each polling station there shall be displayed prominently—
 - (a) a notice specifying the polling area, the electors of which are entitled to vote at the polling station and, when the polling area has more than one polling station, the particulars of the electors so entitled; and
 - (b) a copy of the list of the contesting candidates.
- (2) At each polling station shall be set up one or more Voting Compartments in which the electors can record their votes free from observation.
- (3) The Returning Officer shall provide at each polling station one voting machine and copies of relevant part of the electoral roll and such other election material as may be necessary for taking the poll.
- (4) Without prejudice to the provisions of sub-rule (3), the Returning Officer may with the previous approval of the Election Commission, provide one common voting machine for two or more Polling Stations located in the same premises.

49D. Admission to Polling Stations

The Presiding Officer shall regulate the number of electors to be admitted at any one time inside the polling station and shall exclude there from all persons other than

- (a) Polling Officers;
- (b) public servants on duty in connection with the election;
- (c) persons authorised by the Election Commission;
- (d) candidates, their Election Agents and subject to the provisions of rule 13, one Polling Agent of each Candidate;
- (e) a child in arms accompanying an elector;
- (f) a person accompanying a blind or infirm elector who can not move without help; and
- (g) such other person as the Returning Officer or the Presiding Officer may employ under sub-rule (2) of rule 49G or sub-rule (1) of rule 49H.

49E. Preparation of voting machine for poll

The Control Unit and Balloting Unit of every voting machine used at Polling Station and the printer for paper trail where used, shall bear a label marked with-

- (a) the serial number, if any, and the name of the constituency;
 - (b) the serial number and name of the polling station or stations, as the case may be;
 - (c) the serial number of the unit; and
 - (d) the date of poll.
- (2) Immediately before the commencement of the poll, the Presiding Officer shall demonstrate to the Polling Agents and other person present that no vote has been already recorded in the voting machine and if bears the label referred to in sub-rule (1), and where the printer for paper trail is used that the drop box of the printer is empty.
 - (3) A paper seal shall be used for securing the Control Unit of the voting machine, and the Presiding Officer shall affix his own signature on the paper seal and obtain thereon the signature of such of the Polling Agents present as are desirous of affixing the same.
 - (4) The Presiding Officer shall thereafter fix the paper seal so signed in the space meant therefor in the Control Unit of the voting machine and shall secure and seal the same.
 - (5) The seal used for securing the Control Unit shall be fixed in such manner that after the unit has been sealed, it is not possible to press the “result button” without breaking the seal.
 - (6) The control unit shall be closed and secured and placed in full view of the Presiding Officer and the Polling Agents and the Balloting Unit placed in the Voting Compartment.
 - (7) Where the printer for the paper trail is used, the printer shall also be kept along with the Balloting Unit in the Voting Compartment and shall be connected to the Electronic Voting Machine in the manner as directed by the Election Commission.

49F. Marked copy of electoral roll

Immediately before the commencement of the poll, the Presiding Officer shall also demonstrate to the Polling Agents and others present that the marked copy of the electoral roll to be used during the poll does not contain-

- (a) any entry other than that made in pursuance of clause (b) sub-rule (2) of rule 20; and (EDC – Election Duty Certificate)
- (b) any mark other than the mark made in pursuance of the clause (b) of sub rule (2) of rule 23. (PB – Postal Ballot)

49G. Facilities for women electors

- (1) Where a polling station is for both men and women electors, the Presiding Officer may direct that they shall be admitted into the polling station alternately in separate batches.
- (2) The Returning Officer or the Presiding Officer may appoint a woman to serve as an attendant at any polling station to assist women electors and also to assist the Presiding Officer generally in taking the poll in respect of women electors, and in particular, to help frisking any women elector in case it becomes necessary.

49H. Identification of electors

- (1) The Presiding Officer may employ at the polling station such persons as he thinks fit to help in the identification of the electors or to assist him otherwise in taking the poll.
- (2) As each elector enters the polling station, the Presiding Officer or the Polling Officer authorised by him in this behalf shall check the elector’s name and other particulars with the relevant entry in the electoral roll and then call out the serial number, name and other particulars of the elector.
- (3) Where the polling station is situated in a constituency, electors of which have been supplied

with identity cards under the provisions of the Registration of Electors Rules, 1960, the elector shall produce his identity card before the Presiding Officer or the Polling Officer authorised by him in this behalf.

- (4) In deciding the right of a person to cast his vote the Presiding Officer or the Polling Officer, as the case may be, shall over-look the clerical or printing errors in an entry in the electoral roll if he is satisfied that such person is identical with the elector to whom such entry relates.

49I. Facilities for public servants on election duty

- (1) The provision of rule 49H shall not apply to any person who produces at the polling station an election duty certificate in Form12B and seeks permission to cast his vote at that polling station although it is different from the one where he is entitled to vote.
- (2) On production of such certificate, the Presiding Officer shall
 - (a) obtain thereon, the signature of the person producing it;
 - (b) have the person's name and electoral roll number as mentioned in the certificate entered at the end of the marked copy of the electoral roll; and
 - (c) permit him to cast his vote in the same manner as for an elector entitled to vote at that polling station.

49J. Challenging of identity

- (1) Any Polling Agent may challenge the identity of a person claiming to be a particular elector by first depositing a sum of two rupees in cash with Presiding Officer for each such challenge.
- (2) On such deposit being made, the Presiding Officer shall
 - (a) warn the person challenged of the penalty for personation;
 - (b) read the relevant entry in the electoral roll in full and ask him whether he is the person referred to in that entry;
 - (c) enter his name and address in the list of challenged votes in Form14;
 - (d) require him to affix his signature in the said list.
- (3) The Presiding Officer shall thereafter hold a summary inquiry into the challenge and may for that purpose -
 - (a) require the challenger to adduce evidence in proof of the challenge and the person challenged to adduce evidence in proof of his identity;
 - (b) put to the person challenged any questions necessary for the purpose of establishing his identify and require him to answer them on oath; and
 - (c) administer an oath to the person challenged and any other person offering to give evidence.
- (4) If, after the inquiry, the Presiding Officer considers that the challenge has not been established he shall allow the person challenged to vote; and if he considers that the challenge has been established, he shall debar the person challenged from voting.
- (5) If the Presiding Officer is of the opinion that the challenge is frivolous or has not been made in good faith, he shall direct that the deposit made under sub- rule (1) be forfeited to Government and in any other case, returned to the challenger at the conclusion of the inquiry.

49K. Safeguards against personation

- (1) Every elector about whose identity the Presiding Officer or the Polling Officer, as the case may be, is satisfied, shall allow his left index finger to be inspected by the Presiding Officer or Polling Officer and an indelible ink mark to be put on it.
- (2) If any elector—
 - (a) refuses to allow his left index finger to be inspected or marked in accordance with sub-

rule (1) or already has such a mark on his left index finger or does any act with a view to removing the ink mark, or

- (b) fails or refuses to produce his identify card as required by sub-rule (3) of rule 49H he shall not be allowed to vote.
- (3) Where a poll is taken simultaneously in a Parliamentary Constituency and an Assembly Constituency, an elector whose left index finger has been marked with indelible ink or who has produced his identity card atone such election, shall notwithstanding anything contained in sub-rules (1) and (2) be permitted to cast his vote for the other election.
- (4) Any reference in this rule to the left index finger of an elector shall, in the case where the elector has his left index finger missing, be construed as a reference to any other finger to his left hand, and shall, in the case where all the fingers of his left hand are missing, be construed as a reference to the index finger or any other finger of his right hand, and shall in the case where all his fingers of both the hands are missing be construed as a reference to such extremity of his left or right arm as he possesses.

49L. Procedure for voting-by-voting machines

- (1) Before permitting an elector to vote, the Polling Officer shall –
 - (a) record the electoral roll number of the elector as entered in the marked copy of the electoral roll in a Register of Voters in Form 17A;
 - (b) obtain the signature or the thumb impression of the elector on the said Register of Voters; and
 - (c) mark the name of the elector in the marked copy of the electoral roll to indicate that he has been allowed to vote;
 - (d) give details of the document produced by the elector in proof of his/her identification; Provided that no elector shall be allowed to vote unless he has put his signature or thumb impression on the register of voters.
- (2) Not withstanding anything contained in sub-rule (2) of Rule2, it shall not be necessary for any Presiding Officer or Polling Officer or any other officer to attest the thumb impression of the elector on the Register of Voters.

49M. Maintenance of secrecy of voting by electors within the polling station and voting procedures

- (1) Every elector who has been permitted to vote under rule 49L shall maintain secrecy of voting within the polling station and for that purpose observe the voting procedure hereinafter laid down.
- (2) Immediately on being permitted to vote the elector shall proceed to the Presiding Officer or the Polling Officer in charge of the Control Unit of the voting machine who shall, by pressing the appropriate button on the Control Unit, activate the Balloting Unit; for recording of elector's vote.
- (3) The elector shall thereafter forthwith
 - (a) proceed to the Voting Compartment;
 - (b) record his vote by pressing the button on the Balloting Unit against the name and symbol of the candidate for whom he intends to vote; and
 - (c) come out of the Voting Compartment and leave the polling station.

Provided that where printer for paper trail is used, upon casting the vote by pressing the Button as referred to in clause (b), the elector shall be able to view through the transparent window of the printer, kept along with the Balloting Unit inside the Voting Compartment, the printed paper slip showing the serial number, name and the symbol of the candidate for whom he has cast his vote before such paper slip gets cut and drops in the drop box of the printer.

- (4) Every elector shall vote without undue delay.
- (5) No elector shall be allowed to enter the Voting Compartment when another elector is inside it.
- (6) If an elector who has been permitted to vote under rule 49L or rule 49P refuses after warning given by the Presiding Officer to observe the procedure laid down in sub-rule (3) of the said rules, the Presiding Officer or a Polling Officer under the direction of the Presiding Officer shall not allow such elector to vote.
- (7) Where an elector is not allowed to vote under sub-rule (6), a remark to the effect that voting procedure has been violated shall be made against the elector's name in the Register of Voters in Form 17A by the Presiding Officer under his signature.

49MA. Procedure in case of complaint about particulars printed on paper slip. –

- (1) Where printer for paper trail is used, if an elector after having recorded his vote under rule 49M alleges that the paper slip generated by the printer has shown the name or symbol of a candidate other than the one he voted for, the Presiding Officer shall obtain a written declaration from the elector as to the allegation, after warning the elector about the consequence of making a false declaration.
- (2) If the elector gives the written declaration referred to in sub-rule (1), the Presiding Officer shall make a second entry related to that elector in Form 17A, and permit the elector to record a test vote in the voting machine in his presence and in the presence of the candidates or Polling Agents who may be present in the Polling Station, and observe the paper slip generated by the printer.
- (3) If the allegation is found true, the Presiding Officer shall report the facts immediately to the Returning Officer, stop further recording of votes in that voting machine and act as per the direction that may be given by the Returning Officer.
- (4) If, however, the allegation is found to be false and the paper slip so generated under sub-rule (1) matches with the test vote recorded by the elector under sub-rule (2), then, the Presiding Officer shall-
 - (i) make a remark to that effect against the second entry relating to that elector in Form 17A mentioning the serial number and name of the candidate for whom such test vote has been recorded;
 - (ii) obtain the signature or thumb impression of that elector against such remarks; and
 - (iii) make necessary entries regarding such test vote in item 5 in Part I of Form 17C.

49N. Recording of votes of blind or infirm electors

- (1) If the Presiding Officer is satisfied that owing to blindness or other physical infirmities an elector is unable to recognise the symbol on the Balloting Unit of the voting machine or unable to record his vote by pressing the appropriate button thereon without assistance the Presiding Officer shall permit the elector to take with him a companion of not less than eighteen years of age to the Voting Compartment for recording the vote on his behalf and in accordance with his wishes;

Provided that no person shall be permitted to act as the companion of more than one elector at any Polling Station on the same day;

Provided further that before any person is permitted to act as the companion of an elector on any day under this rule that person shall be required to declare that he will keep secret the vote recorded by him on behalf of the elector and that he has not already acted as the companion of any other elector at any other Polling Station on that day.

- (2) The Presiding Officer shall keep a record in Form 14A of all cases under this rule.

49O. Elector deciding not to vote

If an elector, after his electoral roll number has been duly entered in the Register of Voters in Form 17A and has put his signature or thumb impression thereon as required under sub-rule (1) of

rule 49L, decides not to record his vote, a remark to this effect shall be made against the said entry in Form 17A by the Presiding Officer and the signature or thumb impression of the elector shall be obtained against such remark.

49P. Tendered Votes

- (1) If a person representing himself to be a particular elector seeks to vote after another person has already voted as such elector, he shall, on satisfactorily answering such questions relating to his identity as the Presiding Officer may ask, be, instead of being allowed to vote through the Balloting Unit, supplied with a tendered ballot paper which shall be of such design, and the particulars of which shall be in such language or languages as the Election Commission may specify.
- (2) Every such elector shall before being supplied with tendered ballot paper write his name against the entry relating to him in Form 17B.
- (3) On receiving the ballot paper, he shall forthwith—
 - (a) proceed to the Voting Compartment;
 - (b) record there his vote on the ballot paper by placing a cross mark 'X' with the instrument or article supplied for the purpose on or near the symbol of the candidate for whom he intends to vote;
 - (c) fold the ballot so as to conceal his vote;
 - (d) show to the Presiding Officer, if required, the distinguishing mark on the ballot paper;
 - (e) give it to the Presiding Officer who shall place it in a cover specially kept for the purpose; and
 - (f) leave the polling station.
- (4) If owing blindness or physical infirmities, such elector is unable to record his vote without assistance; the Presiding Officer shall permit him to take with him a companion, subject to the same conditions and after following the same procedure as laid down in rule 49N for recording the vote in accordance with his wishes.

49Q. Presiding Officer's entry in the Voting Compartment during poll

- (1) The Presiding Officer may whenever he considers it necessary so to do, enter the Voting Compartment during poll and take such steps as may be necessary to ensure that the Balloting Unit is not tampered or interfered with in any way.
- (2) If the Presiding Officer has reason to suspect that an elector who has entered the Voting Compartment is tampering or otherwise interfering with the Balloting Unit or has remained inside the Voting Compartment for unduly long period, he shall enter the Voting Compartment and take such steps as may be necessary to ensure the smooth and orderly progress of the poll.
- (3) Whenever the Presiding Officer enters the Voting Compartment under this rule, he shall permit the Polling Agents present to accompany him if they so desire.

49R. Closing of Poll

- (1) The Presiding Officer shall close a polling station at the hour fixed in that behalf under section 56 and shall not thereafter admit any elector into the polling station:

Provided that all electors present at the polling station before it is closed shall be allowed to cast their votes.
- (2) If any question arises whether an elector was present at the polling station before it was closed it shall be decided by the Presiding Officer and his decision shall be final.

49S. Account of votes recorded

- (1) The Presiding Officer shall at the close of the poll prepare an account of votes recorded in

Form 17C and enclose it in a separate cover with the words 'Account of Votes Recorded' superscribed thereon.

- (2) The Presiding Officer shall furnish to every polling agent present at the close of the poll a true copy of the entries made in Form-17C after obtaining a receipt from the said Polling Agent therefore and shall attest it as a true copy.

49T. Sealing of voting machine after poll

- (1) As soon as practicable after the closing of the poll, the Presiding Officer shall close the Control Unit to ensure that no further votes can be recorded and shall detach the Balloting Unit from the Control Unit and from the printer, where printer is also used, so however, that the paper slips contained in the drop box of the printer shall remain intact.
- (2) The Control Unit, the Balloting Unit and the Printer, where it is used, shall thereafter be sealed, and secured separately in such manner as the Election Commission may direct and the seal used for securing them shall be so affixed that it will not be possible to open the units without breaking the seals.
- (3) The Polling Agents present at the polling station, who desire to affix their seals, shall also be permitted to do so.

49U. Sealing of other packets

- (1) The Presiding Officer shall then make into separate packet –
 - (a) the marked copy of the electoral roll;
 - (b) the Register of Voters in Form 17A;
 - (c) the cover containing the tendered ballot papers and the list in Form 17B;
 - (d) the list of challenged votes; and
 - (e) any other papers directed by the Election Commission to be kept in a sealed packet.
- (2) Each packet shall be sealed with the seal of the Presiding Officer and with the seal either of the candidate or of his Election Agent or of his Polling Agent who may be present at the polling station and may desire to affix his seal thereon.

49V. Transmission of voting machines, etc., to the Returning Officer

- (1) The Presiding Officer shall then deliver or cause to be delivered to the Returning Officer at such place as the Returning Officer may direct, –
 - (a) the voting machine;
 - (b) the account of votes recorded in Form 17C;
 - (c) the sealed packets referred to in rule 49U; and
 - (d) all other papers used at the poll.
- (2) The Returning Officer shall make adequate arrangements for the safe transport of the voting machine, packets and other papers for their safe custody until the commencement of the counting of votes.

49W. Procedure on adjournment of poll

- (1) If the poll at any polling station is adjourned under sub-section (1) of section 57, the provision of rules 49S to 49V shall, as far as practicable, apply as if the poll was closed at the hour fixed in that behalf under section 56.
- (2) When an adjourned poll is recommended under sub-section (2) of section 57, the electors who have already voted at the poll so adjourned shall not be allowed to vote again.
- (3) The Returning Officer shall provide the Presiding Officer of the polling station at which such adjourned poll is held, with the sealed packet containing the marked copy of the electoral roll, Register of Voters in Form 17A and a new voting machine.

- (4) The Presiding Officer shall open the sealed packet in the presence of the Polling Agents present and use the marked copy of the electoral roll for marking the names of the electors who are allowed to vote at the adjourned poll.
- (5) The provisions of rule 28 and rules 49A to 49V shall apply in relation to the conduct of an adjourned poll before it was so adjourned.

49X. Closing of voting machine in case of booth capturing

Where the Presiding Officer is of opinion that booth capturing is taking place at a Polling Station or at a place fixed for the poll, he shall immediately close the Control Unit of the voting machine to ensure that no further votes can be recorded and shall detach the Balloting Unit from the Control Unit.

ANNEXURE – 3

(CHAPTER – 1, Para 1.6)

LIST OF POLLING MATERIALS FOR A POLLING STATION

S. No.	Items	Quantity
(A)	EVM, Electoral Rolls and others	
1	Control Unit	01 Nos
2	Ballot Units	01 or more depending upon the number of candidates plus NOTA
3	VVPAT	01Nos
4	Marked copy of electoral roll	01Nos
5	Working copies of electoral roll	03 Nos
6	Ballot papers (for tendered votes)	20 Nos
7	ASD List	01Nos
8	CSV List if any	01Nos
9	Braille Ballot Sheet	01Nos
10	Dummy Ballot Unit	01Nos
11	Voting Compartment	01 Nos as per design approved by Commission
(B)	Forms and other formats:	
1	Statutory Booklet-01: White Colour Register	01 Nos
	(i) Register of voters in Form 17A	
2	Statutory Booklet-02: White Colour Booklet	01 Nos
	(i) List of Tendered votes in Form-17 B	02 Nos
	(ii) The account of votes (Form-17C) recorded	10+ Nos,(Depending upon the number of candidates)
	(iii) List of challenged votes in Form-14	02 Nos
	(iv) List of blind and infirm electors in Form 14A	02 Nos
	In case of simultaneous election, for Assembly election, addition accounts of votes (17C) recorded should be given in pink colour	10+ Nos,(Depending upon the number of candidates in the assembly election)
3	Statutory Booklet-03: White Colour Booklet	01 Nos
	(i) Voter's Slip	Number of voter's slip shall be depended upon the number of voters in that booth.
	In case of simultaneous election, for Assembly election, Voter's Slip Pink Booklet should be provided.	Same as above
4	Non-statutory Booklet- Part-A: Yellow Colour Booklet	01 Nos
	(i) The declarations by the Presiding Officer before the commencement of poll and at the end of poll (Part-I to IV)	02 Nos
	(ii) The Presiding Officer's Diary	02 Nos
	(iii) Visit Sheet	02 Nos
	(iv) Presiding Officer's Report (I, II, III, IV & V)	01 Nos
	(v) Form M21- Receipts of return of election records and materials after poll	02 Nos
5	Non-statutory Booklet- Part-B: Yellow Colour Booklet	01 Nos
	(i) Polling Agents/ relieving agents movement sheet;	01 Nos
	(ii) Entry Pass of Polling Agents/Relief Agents	(10 + depending upon the number of candidates)
	(iii) Declarations by the companions of blind and infirm voter	10 Nos
	(iv) The receipt book and cash, if any, in respect of challenged votes;	10 Nos
	(v) Form of declaration by elector under Rule 49MA (Test Vote)	05 Nos
	(vi) Form of declaration by elector whose name is in ADS list	10 Nos
	(vii) Letter of complaint to the S.H.O. Police	04 Nos

	(viii) Declarations obtained from electors as to their age	04 Nos
	(ix) List of Electors who voted after giving declaration/refused to give declaration	04 Nos
6	Candidate Information Booklet-06: Blue Colour Booklet	01 Nos
	(i) List of contesting candidates Form-7A	01 Nos
	(ii) Photo copy of signature of Candidates/Agents	01 Nos
(C)	Envelopes	
1	Envelope Set-01: EVM Papers (White colour)	
	(i) Master envelope for EVM papers (White colour)	01 Nos,
	(ii) Envelope for account of votes (Form-17C) recorded	01 Nos
	(iii) Envelope for Presiding Officers Report- I (Mock Poll Certificate), II & III	01 Nos
	(iv) Envelope for VVPAT paper slip of Mock Poll (Black Colour)	01 Nos
	In case of simultaneous election, for assembly election, one addition Master envelope for EVM Papers in pink colour, one additional Envelope for account of votes recorded (17C) in pink colour and one additional envelope for Presiding Officer's Report-I (Mock Poll Certificate), II & III in pink color and one additional envelope for VVPAT paper slips of Mock poll in black colour for assembly poll EVM.	01 Nos each
2	Envelope Set-02: Scrutiny Documents (White Colour)	
	(i) Master Envelope for Security Documents (White Colour)	01 Nos
	(ii) Envelope for Presiding Officer's Diary (White colour)	01 Nos
	(iii) Envelope for register of voters (17A) (White Colour)	01 Nos
	(vi) Envelope for the list of blind and infirm electors in Form 14-A and the declarations of the companions (Yellow colour)	01 Nos
	(v) Envelope for Visit Sheet (White colour)	01 Nos
3	Envelope Set-03: Statutory Cover (White colour)	
	(i) Master envelope for Statutory Cover (White colour)	01 Nos
	(ii) Envelope for marked copy of the electoral roll and list of CSV (If any) (White colour)	01 Nos
	(iii) Envelope for voter's slips (White colour)	01 Nos
	(iv) Envelope for used tendered ballot papers and the list in Form 17B (White colour)	01 Nos
	(v) Envelope for unused tendered ballot papers (white colour)	01 Nos
	(vi) Envelope for the list of challenged votes in Form 14 (white colour)	01 Nos
	In case of simultaneous election, for assembly election, one additional Envelope for Voter's slip (Pink Colour)	01 Nos
4	Envelope Set-04: Non-Statutory Cover (Yellow colour)	
	(i) Master envelope for non-Statutory Cover (Yellow colour)	01 Nos
	(ii) Envelope for Copy or copies of electoral roll (other than the marked copy) (Yellow colour)	01 Nos
	(iii) Envelope for appointment letters of Polling Agents in Form 10 (Yellow colour)	01 Nos
	(iv) Envelope for election duty certificate in Form 12-B (Yellow colour)	01 Nos
	(v) Envelope for declarations by the Presiding Officer (Yellow Colour)	01 Nos
	(vi) Envelop for the receipt book and cash, if any, in respect of challenged votes (Yellow colour)	01 Nos
	(vii) Envelope for (i) unused and damaged paper seals and (ii) Unused and damaged special tags (Yellow colour)	01 Nos
	(viii) Envelope for Unused Voter's Slip (Yellow Colour)	01 Nos
	(ix) Envelope for the declarations obtained from electors as to their age and the list of such electors and the list of electors who have refused to make declarations as to their age (Yellow Colour)	01 Nos
	x) Envelope for the Form of declaration by elector under 49MA	01 Nos
	xi) Envelope for Form of declaration by elector whose name is in ASD list	01 Nos.
	xii) Envelope containing letter of complaint to SHO	01 Nos
	In case of simultaneous, one additional envelope for declaration by the Presiding Officer in pink colour for assembly poll.	
5	Envelope Set-5: Handbook, Instructions and other (Brown Colour)	
	(i) Master Envelope for Handbooks, Instructions, etc (Brown Colour)	01 Nos

	(ii) Envelope for (i) Used and remaining Indelible Ink Phials) and (ii) Used Stam Pad (Brown Colour)	
6	Envelope for other polling materials (Blue colour)	01 Nos
(D)	Seals, Tags and Marks	
1	Common Address tags for Ballot unit, Control Unit and VVPAT	14 Nos
2	Special Tags	03 Nos
3	Green paper seals for EVM	03 Nos
4	Indelible Ink	02 Phials of 10CC
5	Rubber stamp with arrow cross mark	01 Nos
6	Metal seal for Presiding Officer	01 Nos
7	Distinguishing mark rubber stamp	01 Nos
8	Pink Paper seal for sealing Black Envelope	02 Nos
9	Mock Poll Slip Stamp	01 Nos
(E)	Handbooks and Instructions	
	(i) The Hand Book for Presiding Officer	01 Nos
	(ii) Instructions of Electronic Voting Machine & VVPAT	
	(a) Poster on How to cast vote on EVM & VVPAT	01 Nos
	(b) Brochure for Presiding Officer on use of EVM & VVPAT	01 Nos
	(c) Trouble shooting on use of EVM & VVPAT	01 Nos
	(iii) Mock Poll leaflet	01 Nos
	(iv) Commission order of identification of electors through alternative documents	01 Nos
	(v) Phone Book/Contact Book for Polling parties	01 Nos
	(vi) Checklist of Presiding Officer	01 Nos
(F)	Stationery items	
1	Stamp pad (purple)	01Nos
2	Match box	01Nos
3	Sign Boards	
	(i) Presiding Officer	01 Nos
	(ii) Polling officer-1	01 Nos
	(iii) Polling Officer-2	01 Nos
	(iv) Polling Officer-2	01 Nos
	(v) Entry	01 Nos
	(vi) Exit	01 Nos
	(vii) Male	01 Nos
	(viii) Female	01 Nos
	(ix) Polling Agent	01 Nos
	(x) You are under WEB CASTING/CCTV surveillance	04 Nos
	(xi) Miscellaneous notice specifying area, etc as required by under Rule 31(1)(a) of The Conduct of Elections Rules 1961	01 Nos
4	Ordinary pencil	01 Nos
5	Ball pen (three blue, one red and one silver white)	05 Nos
6	Blank paper	08 sheets
7	Pins	25 Nos
8	Sealing wax	06 sticks
9	Gum paste	01 Nos
10	Blade	01 Nos
11	Candle sticks	04 sticks
12	Thin twine thread	20 meters
13	Metal rule	01 Nos
14	Carbon paper	03 Nos
15	Cloth or rag for removing oil etc.	small quantity
16	Packing paper sheets	03 Nos
17	Cup/empty tin/plastic box for holding indelible ink bottle	01 Nos
18	Drawing pins	24 pieces
19	Rubber bands	20 Nos
20	Transparent Adhesive tape	01 Nos

ANNEXURE – 4
(Chapter – 1, Para 1.8)

CERTIFICATE REGARDING THE ROLL TO BE USED AS MARKED COPY
Certificate

(Where the roll is reprinted to reflect deletions and corrections in the Supplement No.1 & 2)

This to certify that the electoral roll of Part No. ofAssembly Constituency, reprinted after reflecting the deletions and corrections shown in Supplement Nos. 1 & 2 has been thoroughly compared and no discrepancy has been found. There are total numbers of pages (from 1 to_____)

Dated:

Signature & Seal of
the Returning Officer/Asstt. Returning
Officer

OR

Certificate

(Where discrepancies are noticed in the reprinted roll on comparison with the finally published roll and the roll finally published and Supplement No.2 of continuous updating is used for preparing working/ marked copies instead of the reprinted roll.)

This to certify that the electoral roll of Part No. ofAssembly Constituency is prepared using the finally published roll and the Supplement No.2 thereof. There are total numbers of pages (From 1 to_). This is the authentic copy of the electoral roll and in case of any discrepancy, whatsoever, this roll shall prevail.

Dated:

Signature & Seal of
the Returning Officer/Asstt. Returning
Officer

ANNEXURE – 5

(Chapter – 1, Para 1.12)

PRESIDING OFFICER’S REPORT

PART-I: MOCK POLL CERTIFICATE

Name of election:..... (to be pre-printed)

No. and Name of AC/AS:.....(to be pre-printed)

No. and Name of PC:(to be pre-printed)

Polling Station No:

(a) Conduct of mock poll and verification of mock poll data

S. No.	Name of Candidate (Name of Candidates including NOTA to be pre-printed)	Number of votes cast during the mock poll	Number of votes displayed in CU on checking the result	Number of VVPAT printed Paper slips against Candidates	Result displayed in CU & Printed Paper Slips count tallied with each other (Yes/No)	Signature of Polling agents with party abbreviation / Independent
1.						
2.						
3.						
4.						
5.						
6.						
7.						
8.						
9.						
	NOTA					
	TOTAL					

(b) ‘CLEAR’ button on the Control Unit has been pressed to clear mock poll data (Yes/No). If yes, then write the above sentence in ink.

(c) All paper slips taken out from VVPAT after mock poll (Yes/No)

(d) Empty VVPAT shown to all Polling Agents (Yes/No)

(e) Before actual poll ensure that no printed paper slip is in VVPAT Drop Box and shown to Polling Agents (Yes/No)

(f) ‘TOTAL’ button on the Control Unit has been pressed to show total vote ‘ O ’ to polling agent (Yes/No)

(g) Mock poll VVPAT slips stamped with ‘MOCK POLL SLIP’ and sealed in black envelope and then sealed with Pink Paper Slip (Yes/No)

(h) Following witness Mock Poll and certify that mock votes tallied and that the mock votes erased from CU after mock poll:

S. No.	Name of Polling Agent	Name of Party	Name of Candidate	Signature of Polling Agent

- (i) Time display on the Control Unit is minutes more/less than Indian standard Time (IST), if any.
- (j) Signature of Micro-ObsERVER (if posted at the polling station)

Name and/ signature of the Presiding Officer

(I) It is, hereby, certify that before commencement of actual poll, ‘TOTAL’ button of the Control Unit has been pressed in the presence of all polling officials to ensure that ‘**Total Vote is 0**’. Tick the appropriate observation:

(i) Control Unit shows total vote : 0

OR

(i) *Control Unit shows total vote more than ‘0’ (means mock poll votes not cleared), hence, clear the mock poll data.*

(Signature of Presiding Officer)

Following witness the above process and certify that mock votes erased from the Control Unit and mock poll VVPAT slips removed from the VVPAT before start of actual poll:

S. No.	Name of Polling officer	Signature

PRESIDING OFFICER'S REPORT

(Chapter – 4, Para 4.6)

PART-II: POWER PACK REPLACEMENT IN CU

(TO BE FILLED DURING MOCK POLL, POLL & AFTER COMPLETION OF POLL
DEPENDING ON CASE/SITUATION)

Name of Election: (to be pre-printed)

No. and Name of AC/AS:(to be pre-printed)

No. and Name of PC: (to be pre-printed)

Polling Station No:

(a) Details of replacement of Power Pack of the Control Unit during mock poll/actual poll (strike out which one is not applicable)

(i) Unique ID of Control Unit:

(ii) Reason for replacement of Power Pack of the Control Unit:
.....

(iii) Unique ID of old address tag that was cut by the Presiding Officer to replace the Power Pack of the Control Unit

(b) Following Polling Agents witness the replacement of power pack from the Control Unit:

S. No.	Name of Polling Agent	Name of Party	Name of Candidate	Signature of Polling Agent

Repeat the above information in same format, if multiple replacements happen.

Signature of Presiding Officer

Signature of Sector Officer

PRESIDING OFFICER'S REPORT

(Chapter – 1, Para 1.13)

PART-III: PRESSING OF CLOSE BUTTON AFTER COMPLETION OF POLL

Name of Election: (to be pre-printed)

No. and Name of AC/AS:(to be pre-printed)

No. and Name of PC: (to be pre-printed)

Date of Poll..... (to be pre-printed)

No. and Name of Polling Station: (to be pre-printed)

It is certified that I have pressed the “Close Button” of the Control Unit at the end of poll in the presence of the following:

S. No.	Name & Designation of the Polling Officer	Signature

S. No.	Name of Polling Agent	Name of Party / Independent	Name of Candidate	Signature of Polling Agent

Signature of Presiding Officer

PRESIDING OFFICER'S REPORT

(Chapter – 1, Para 1.14)

PART-IV: EVM/VVPAT REPLACEMENT

(TO BE FILLED DURING MOCK POLL, IF THERE IS ANY REPLACEMENT)

Name of Election: (to be pre-printed)

No. and Name of AC/AS:(to be pre-printed)

No. and Name of PC: (to be pre-printed)

Polling Station No. (to be pre-printed)

1.

a) Details of Electronic Voting Machine and VVPAT used-

{BU- Balloting Unit, CU- Control Unit and VVPAT- Voter Verifiable Paper Audit Trail}

S. No.	Particulars	BU	CU	VVPAT	Signature of Sector Officers in case of replacement
1.	Unique ID of units given at the time of dispersal				
2.	(a) Tick (-Y) which one found non-functional during mock poll				
	(b) Reason for nonfunctioning (Mention error/code noticed in CU)				
3.	Unique ID of unit(s) given as replacement during mock poll				

b) Following Polling Agents witness the replacement process

S. No.	Name of Polling Agent	Name of Party / Independent	Name of Candidate	Signature of Polling Agent

(Signature of Presiding Officer)

PRESIDING OFFICER'S REPORT

(Chapter – 1, Para 1.14)

PART-V: EVM/VVPAT REPLACEMENT

(TO BE FILLED DURING POLL & AFTER COMPLETION OF POLL DEPENDING ON CASE/SITUATION)

Name of Election: (to be pre-printed)

No. and Name of AC/AS:(to be pre-printed)

No. and Name of PC:(to be pre-printed)

Polling Station No.(to be pre-printed)

(a) Replacement of EVM and VVPAT during actual poll process

S. No.	Particulars	BU	CU	VVPAT
1.	(a) Unique ID of unit(s) found non-functional during actual poll			
	(b) Time of occurrence of defects			
	(c) No. of votes recorded in the Control Unit by the time the unit(s) got nonfunctional			
	(d) Reason for non-functioning tarnation error/code noticed in CU)			
	(e) Beep Sound is heard			
	(f) Unique ID of new unit(s) provided as replacement			
	(g) Time of re-starting poll			
2.	Remarks, if any			

(b) Following Polling Agents witness the replacement process during actual poll:

S. No.	Name of Polling Agent	Name of Party	Name of Candidate	Signature of Polling Agent

Repeat the above information in same format, if multiple replacements happen.

Signature of Presiding Officer

Signature of Sector Officer

ANNEXURE - 6
(CHAPTER – 1, Para 1.12)

DECLARATION BY THE PRESIDING OFFICER

PART-I

Declaration by the Presiding Officer before the commencement of the poll

Election from.Parliamentary/Assembly Constituency

Serial No. and name of Polling Station

Date of Poll

I hereby declare:

- (1) that I have demonstrated to the polling agents and other persons present –
 - (a) by holding a mock poll that the voting machine is in perfect working order and that no vote is already recorded therein; After mock poll we have cleared the mock poll data from EVM (CU), and removed the print paper slips from VVPAT drop box.
 - b) that the marked copy of the electoral roll to be used during the poll does not contain any marks other than those used for issuing postal ballot papers and election duty certificates;
 - (c) that the Register of Voters (Form 17A) to be used during the poll does not contain any entry in respect of any elector;
- (2) that I have affixed my own signature on the paper seal(s) used for securing the result section of Control Unit of the voting machine and obtained thereon the signatures of such of the polling agents as are present and desirous of affixing the same.
- (3) that I have written the serial number of the Control Unit on the special address tag, and I have affixed my signature on the back side of the special address tag and also obtained thereon the signatures of such of the candidates/polling agents as are present and desirous of affixing their signature.
- (4) that I have affixed my signature on the modified new green paper seal and also obtained thereon the signatures of such candidates/polling agents as are present and desirous of affixing their signature.
- (5) that I have read out the pre-printed serial number of the special address tag and asked the candidates/polling agents present, to note down the serial number.

Signature of Presiding Officer.....

Signature of polling agents:

- | | |
|----------------------------|------------------------------|
| 1.....(of candidate.....) | 2.....(of candidate.) |
| 3.....(of candidate.....) | 4. (of candidate.) |
| 5.....(of candidate.....) | 6. (of candidate.) |
| 7.....(of candidate | 8. (of candidate.) |
| 9.....(of candidate.) | |

The following polling agent(s) declined to affix his/her/their signature(s), on this declaration:

- | | |
|----------------------------|----------------------------|
| 1.....(of candidate) | 2.....(of candidate.....) |
| 3.....(of candidate.....) | 4.....(of candidate... ..) |

Signature.....

Presiding Officer

Date.....

PART II

DECLARATION BY THE PRESIDING OFFICER AT THE TIME OF USE OF SUBSEQUENT VOTING MACHINE, IF ANY,

Election Parliamentary/Assembly Constituency

Serial No. and Name of Polling Station.....

Date of poll.....

I hereby declare:

That due to (please mention the type of error) of BU/CU replacement of the whole EVM including BU/CU/VVPAT has been done.

- (1) that I have demonstrated to the polling agents and other persons present –
 - (a) by holding a mock poll that the voting machine is in perfect working order and that no vote is already recorded therein;
 - b) that the marked copy of the electoral roll to be used during the poll does not contain any marks other than those used for issuing postal ballot papers and election duty certificates;
 - (c) that the Register of Voters (Form 17A) to be used during the poll does not contain any entry in respect of any elector;
- (2) that I have affixed my own signature on the paper seal(s) used for securing the result section of Control Unit of the voting machine and obtained thereon the signatures of such of the polling agents as are present and desirous of affixing the same.
- (3) that I have written the serial number of the Control Unit on the special address tag, and I have affixed my signature on the backside of the special address tag and also obtained thereon the signatures of such of the candidates/Polling Agents as are present and desirous of affixing their signature.
- (4) that I have affixed my signature on the modified new green paper seal and also obtained thereon the signatures of such of the candidates/polling agents as are present and desirous of affixing their signature.
- (5) that I have read out the pre-printed serial number of the special tag and asked the candidates/polling agents present, to note down the serial number.

Signature.....

Presiding Officer

Signature of polling agents:

- | | |
|----------------------------|------------------------------|
| 1.....(of candidate.....) | 2.....(of candidate.) |
| 3.....(of candidate.....) | 4. (of candidate.) |
| 5.....(of candidate.....) | 6. (of candidate.) |
| 7.....(of candidate ..) | 8. (of candidate.) |
| 9.....(of candidate.) | |

The following polling agent(s) declined to affix his/her/their signature(s), on this declaration:

1.....(of candidate

2.....(of candidate.....)

3.....(of candidate.....)

4.....(of candidate... ..)

Signature.....

Presiding Officer

Date.....

PART III

DECLARATION AT THE END OF POLL

I have furnished to the Polling Agents, who were present at the Polling Station at the close of the poll and whose signatures are affixed below, an attested copy of each of the entries in Part-I- Account of Votes Recorded of Form 17C as required under rule 49-S (2) of the Conduct of Elections Rules, 1961.

Signature.....

Presiding Officer

Date.....

Time.....

Received an attested copy of the entries in the accounts of votes recorded (Part I of Form 17C)

Signature of polling agents :

- | | |
|-----------------------------|----------------------------|
| 1. (of candidate.....) | 2.....(of candidate.) |
| 3.....(of candidate.....) | 4.....(of candidate.) |
| 5.....(of candidate.....) | 6..... (of candidate |
| 7. (of candidate.....) | 8.....(of candidate.) |
| 9..... (of candidate.....) | |

The following polling agents who were present at the close of the poll declined to receive an attested copy of Part I of Form 17C and to give a receipt therefor and so an attested copy of that Form was not supplied to them.

- | | |
|----------------------------|-----------------------------|
| 1.....(of candidate.....) | 2.....(of candidate |
| 3.....(of candidate | 4..... (of candidate.) |
| 5.....(of candidate | 6.....(of candidate.) |
| 7.....(of candidate | 8.....(of candidate |
| 9.....(of candidate.) | |

Signature.....

Presiding Officer

Date.....

Time.....

PART IV

DECLARATION AFTER THE SEALING OF THE VOTING MACHINE

I have affixed my seals, and I have allowed the Polling Agents who were present at the Polling Station at the close of poll to affix their seals, on the carrying cases of the Control Unit and Balloting Units of the voting machine.

.....
Signature of Presiding Officer

Date.....

Time.....

The following polling agents have affixed their seals.

Signature of polling agents:

- | | |
|----------------------------|----------------------------|
| 1..... (of candidate.....) | 4.....(of candidate.) |
| 2..... (of candidate.....) | 5.....(of candidate.) |
| 3.....(of candidate.....) | 6.....(of candidate.) |

The following polling agents refused or did not want to affix their seals.

- | | |
|-----------------------------|----------------------------|
| 1.....(of candidate.....) | 3.....(of candidate.) |
| 2..... (of candidate) | 4.....(of candidate.) |

Signature.....
Presiding Officer

Date.....

ANNEXURE - 7
(CHAPTER – 1, Para 1.12)

PRESIDING OFFICER'S DIARY

1. Name of the constituency (in block letters):
2. Date of poll:
3. Number and Name of the polling station:
Whether located in –
 - (i) Government or quasi-government building;
 - (ii) Private Building;
 - (iii) Temporary structure;
4. Number of Polling Officers recruited locally, if any:
5. Appointment of Polling Officer made in the absence of duly appointed Polling Officer, if any, and the reasons of such appointment:
6. Electronic Voting Machine
 - (i) Number of Control Units used:
 - (ii) S. No.(s) of Control Units used:
 - (iii) Number of Balloting Units used:
 - (iv) S. No.(s) of Balloting Units used:
7.
 - (i) Number of paper seals used:
 - (ii) S. Nos. of paper seals used:
- 7A.
 - (i) Number of special tags supplied:
 - (ii) S. No.(s) of special tags supplied:
 - (iii) Number of special tags used:
 - (iv) S. No.(s) of special tags used:
 - (v) S. No.(s) of special tags returned as unused:
- 7B. Applicable in the polling stations where VVPAT system is used
 - (i) No. of Printers used:
 - (ii) S. No.(s) of printer(s):
8. Number of candidates who had appointed polling agents at the polling stations:
9.
 - (i) Number of polling agents present at the commencement of poll:
 - (ii) Number of polling agents who arrived late:
 - (iii) Number of polling agents present at the close of the poll:
10.
 - (i) Total number of voters assigned to the polling station:
 - (ii) Number of electors allowed to vote according to marked copy of the electoral roll:
 - (iii) Total number of electors as entered in the Register of Voters (Form 17-A):
 - (iv) Number of votes recorded as per the voting machine:
 - (v) Number of voters deciding not to record vote, if any:

Signature of the first Polling Officer

Signature of Polling Officer

In-charge of Register of Voters

- 11. Number of electors who voted –
 - Men.....
 - Women.....
 - Third Gender.....
 - Total.....
- 12. Challenged vote –
 - Number allowed.....
 - Number rejected.....
 - Amount forfeited Rs.....
- 13. Number of persons who have voted on production of Election Duty Certificate (EDC):
- 13A. Number of overseas electors who voted:
- 14. Number of electors who voted with the help of companions:
- 15. Number of voters cast through proxy:
- 16. Number of tendered votes:
- 17. No. of electors –
 - (a) From whom declarations as to their age obtained.....
 - (b) Who refused to give such declaration.....
- 18. Whether it was necessary to adjourn the poll and if so, the reasons for such adjournment:
- 19. Number of votes cast in every two hours –
 - From 7 a.m. to 9 a.m.
 - From 9 a.m. to 11 a.m.
 - From 11 a.m. to 1 p.m.
 - From 1 p.m. to 3 p.m.
 - From 3 p.m. to 5 p.m.

(Necessary changes may be made depending on the hours fixed for commencement and close of poll)

19B. Details of visitors at polling stations as per Visit Sheet

S. No.	Name & Designation of the officer visiting (Observer/DEO/RO/ARO/Sector Magistrate/Zonal Magistrate/Patrolling Magistrate)	Time of Visit	Brief description of polling process (Peaceful/Incident, If any)	Number of votes polled till the time of visit	
				As per Form 17	As per the EVM

- 20. (a) Number of slips issued at the closing hour of the poll to electors standing in the queue:

- (b) Time at which poll finally closed after the last such elector cast his/her vote:
21. Electoral offences with details:
Number of cases of –
- (a) Canvassing within one hundred meters of the polling station:
 - (b) Impersonation of voters:
 - (c) Fraudulent defacing, destroying or removal of the list of notice or other documents at the polling station:
 - (d) Bribing of voters:
 - (e) Intimidation of voters and others persons:
 - (f) Booth capturing:
22. Was the poll interrupted or obstructed by –
- (1) Riot:
 - (2) Open violence:
 - (3) Natural calamity:
 - (4) Booth capturing:
 - (5) Failure of voting machine:
 - (6) Any other cause:
- Please give details of the above.
23. Was the poll vitiated by any voting machine used at the polling station having been –
- (a) Unlawfully taken out of the custody of the Presiding Officer:
 - (b) Accidentally or intentionally lost or destroyed:
 - (c) Damaged or tampered with:
- Please give details.
24. Serious complaints, if any, made by the candidate/agents:
25. Number of cases of breach of law and order:
26. Report of mistakes and irregularities committed, if any, at the polling station:
27. Whether the declarations have been made before the commencement of the poll and if necessary, during the course of poll when a new voting machine is used and at the end of the poll as necessary:

Place:

Date:

Presiding Officer

This diary should be forwarded to the Returning Officer with the voting machine, Visit Sheet, and other sealed papers.

ANNEXURE - 8

(CHAPTER – 1, Para 1.12)

FORM 17C

[See rules 49S and 56C (2)]

PART I – ACCOUNT OF VOTES RECORDED

Election to House of the People/Legislative Assembly of the State/Union Territory
from..... constituency.

Number and Name of Polling Station:

Identification Number of voting Machine used at the Polling Station:

Control Unit.....

Balloting Unit.....

VVPAT

- 1. Total number of electors assigned to the Polling Station
- 2. Total number of voters as entered in the Register for Voters (Form 17A)
- 3. Number of voters deciding not to record votes under rule 49-O
- 4. Number of voters not allowed to vote under rule 49M
- 5. Test votes recorded under rule 49MA (d) required to be deducted-

(a) Total number of test votes to be deducted:

Total No.	Sl. No.(s) of elector(s) in Form 17A
.....

(b) Candidate(s) for whom test vote(s) cast:

Sl. No.	Name of candidate	No. of votes
.....
.....

- 6. Total number of votes recorded as per voting machine.....
- 7. Whether the total number of votes as shown against item 6 tallies with the total number of votes as shown against item 2 minus numbers of voters deciding not to record votes as against item 3 minus number of voters as against item 4(i.e. 2-3-4) or any discrepancy noticed.....
- 8. Number of voters to whom tendered Ballot papers were issued under rule 49P.....
- 9. Number of tendered Ballot papers:

	Sl. No.		
	Total	From	To
(a) received for use		
(b) issued to electors		
(c) not used and returned		

10. Account of papers seals

Signature of polling agents

1. Paper seals supplied for use: Total No..... 1.....
Sl.No. from..... To
 2. Paper seals used: Total No..... 2.....
Sl.No. from..... To
 3. Unused paper seals returned to
Returning Officer: Total No..... 3.....
Sl.No. from..... To
 4. Damaged paper seal, if any: Total No..... 4.....
Sl.No. from..... To
- 5.....
6.....

Date.....

Place.....

Signature of Presiding Officer

Polling Station No.....

PART II- RESULT OF COUNTING

Sl. No. of candidate	Name of candidate	Number of votes as displayed on Control Unit	Number of test votes to be deducted as per item 5 of Part I	Number of valid votes. (3-4)
1	2	3	4	5
1.				
2.				
3.				
4.				
5.				
N.	NOTA			
Total				

Whether the total number of votes shown above tallies with the total number of votes shown against item 6 of Part I or any discrepancy noticed between the two totals.

Place.....

Date.....

Signature of Counting Supervisor

Name of candidate/election agent/counting agent

Full signature

- 1.
 - 2.
 - 3.
 - 4.
 - 5.
 - 6.
 - 7.
-

Place.....

Date.....

Signature of Returning Officer

ANNEXURE - 9

(Chapter – 1, Para 1.12)

OUTLINES OF FUNCTIONS TO BE PERFORMED BY PRESIDING OFFICERS AT VARIOUS STAGES

- I. On Appointment.**
- II. On the day previous to the day of Poll.**
- III. On arrival at the Polling Station on the day of Poll.**
- IV. During the hours of Poll.**
- V. After the completion of Poll.**

I. ON APPOINTMENT

1.1. When you receive your appointment order, please check up carefully and examine: -

- (a) The name and number of your polling station;
- (b) The name of the assembly constituency within which the polling station is situated;
- (c) The exact location of your polling station.

This information will be found in your appointment order. You may also find the names of your Polling Officers in the order. Try to contact them and keep their residential and office addresses with you and give your residential and office address to them.

Attend as many training classes as you can, so that you become fully familiar with the operation of the EVM and VVPAT. Never rely on your memory and past experience as they may betray you. The instructions are being changed considerably from time to time.

1.2. Read the following pamphlets and booklets very carefully:

- (a) Handbook for Presiding Officers;
- (b) Manual of EVM and VVPAT;
- (c) Letter of the Returning Officer to Presiding Officers giving important instructions.

1.3. Familiarize yourself with the item of polling material.

1.4. Study carefully the manner and the method in which the Control Unit, Balloting Units, the Control Unit closed and sealed and VVPAT drop box sealed.

1.5. Read carefully different forms, Statutory and Non-Statutory.

1.6. Read very carefully the relevant sections of the Representation of the People Act, 1950 and 1951, given in **Annexure-1** and relevant rules under the Conduct of Elections Rules, 1961, given in **Annexure-2**. If you have any doubt, approach your Returning Officer and get your doubt clarified. Never be in a confused mind.

II. ON THE DAY PREVIOUS TO THE DAY OF POLL

2.1. On the day previous to the day of poll, you will be asked to collect the polling materials for use at the polling station. Please ensure that:

- (a) The Control Unit and Balloting Unit(s) and VVPAT, given to you pertain to your Polling Station. Match all Unit Ids written on the tags with the metallic plate / barcode on the back side of the Unit.
- (b) The 'Candidate Set Section' of Control Unit is duly sealed and address tag is firmly attached thereto.
- (c) The battery in the Control Unit is fully operational.

- (d) The Balloting Unit(s) has been duly sealed and address tags are firmly attached, both at the top and bottom right portion.
- (e) The appropriate ballot paper has been affixed on each Balloting Unit and is properly aligned under the ballot paper screen.
- (f) The slide/thumb wheels switch has been set to the appropriate position in each Balloting Unit.
- (g) All the items of polling materials mentioned in **Annexure -3** have been supplied in required quantity;
- (h) check the serial numbers of paper seals;
- (i) check the electoral roll to ensure that:
 - (1) the copies of the integrated roll are given,
 - (2) the part number of the roll is as per the polling station assigned to the Presiding Officer,
 - (3) page numbers in the working copies of the roll are given serially,
 - (4) the printed serial numbers of voters are not corrected and no new numbers are substituted for them,
- (j) Check the copy of the list of contesting candidates given to you. The names, Photos and symbols of the candidates given in the list must tally and should be in the same serial order in which they appear in the ballot paper on the Balloting Unit. Also check if you have received the following list:
 - 1. Notice on area delineating polling station
 - 2. ASD, AIS and CSV list
- (k) Check that the phial of indelible ink supplied to you contains sufficient quantity of indelible ink and that its cap is perfectly sealed; if not re-seal the cap with candle/wax.
- (l) Check the arrow cross-mark rubber stamp and your brass seals. Ensure that the arrow cross-mark rubber stamp has seals affixed on both the sides and that the stamp pad is not dry. If your polling station is proposed to be located in a temporary structure, obtain iron box of sufficient dimensions to store your election papers.
- (m) If you have any doubt about your movement program, route to be followed to reach the polling station, get them cleared and make sure of the time, the place of departure and mode of transport for reaching the polling station.

- 2.2. (a) Use the dedicated vehicle provided to you and your team for reaching the polling station.
- (b) Reach your polling station latest by 4-00 p.m. on the day previous to the day of poll and ensure that-
 - (i) there is enough space for the voters to wait outside the polling station and for separate queues for male and female voters;
 - (ii) there are separate passages for entry and exit of voters;
 - (iii) a notice showing the polling area and details about voters is prominently displayed;
 - (iv) the copy of the list of contesting candidates is prominently displayed.
- (c) Appoint persons whom you will require to assist in identifying the voters including female assistant.
- (d) Decide the place where you, your Polling Officers and Polling Agents of the candidates will sit and the Control Unit of the voting machine will be placed.
- (e) Remove any photograph of any leader belonging to any political party hung in the polling station or cover them fully.

- 2.3 The voting machine, VVPAT and the polling materials entrusted to you should remain in your custody throughout, till the poll is completed and the voting machine, VVPAT and the materials

are handed over back by you. Either you or one of the Polling Officers selected by you should remain in the polling station in charge of the voting machine, VVPAT and polling materials from the moment you arrive there. The voting machine, VVPAT and polling materials should not be left in the custody of the Police Guard on duty at the polling station or any person other than yourself or a Polling Officer selected by you.

III. ON ARRIVAL AT THE POLLING STATION ON THE DAY OF POLL

- 3.1 Ensure that you and other members of your Polling Party reach the Polling Station on the day previous to the date of poll. On receipt, check the voting machine and the polling materials.
- 3.2. Check up the appointment letters of Polling Agents and explain to them provisions of section 128 of the R.P. Act, 1951. Assign them seats and issue them entry passes for their movements. Read out the declaration as referred to in Chapter - 4.
- 3.3. Make arrangements to appoint a Polling Officer if anyone from your party has not turned up.
- 3.4. Start setting up the voting machine and VVPAT for conduct of mock poll 90 Minutes before the time fixed for commencement of poll.
- 3.5. After the mock poll, clear the data of mock poll in the Control unit and remove paper slips from VVPAT drop box before sealing the Control Unit and VVPAT. Prepare the Mock Poll certificate after taking signatures of the Polling Agents present at the Polling Station. Also report the absence of all Polling Agents or presence of only one polling agent during mock poll to the RO.
- 3.6. Fix the green paper seal and close and seal the result section of the Control Unit. Seal VVPAT drop box.
- 3.7. Place the phial of indelible ink in such a way that the ink does not spill out.

IV. DURING THE HOURS OF POLL

- 4.1. Ensure that the polling starts sharp at the appointed time. Even if all formalities have not been completed, admit some voters in the polling station at the appointed time.
- 4.2. While poll is in progress, unusual complex cases are likely to crop up. Deal with them yourself leaving the Polling Officers' to carry on their normal duties. Such cases will be
 - (a) Challenge to a voter (Chapter - 4)
 - (b) Voting by minors (Chapter - 4)
 - (c) Voting by blind or infirm voters (Chapter - 5)
 - (d) Voters deciding not to vote (Chapter - 5)
 - (e) Tendered votes (Chapter - 5)
 - (f) Breach of secrecy of voting (Chapter - 5)
 - (g) Disorderly conduct at the booth and removal of disorderly persons (Chapter - 4)
 - (h) Adjournment of poll because of riot or any other cause (Chapter - 6)
 - (i) Complaint about particulars printed on VVPAT paper slip. (Chapter - 4)
- 4.3. Collect statistical information for compilation of item 19 of your diary regarding polling every two hours. Also collect information about the electors who have voted using Braille ballot.
- 4.4. Close the poll at the appointed hour even if it has started late. Give slips with your signature to those persons who are in the queue at this hour. Ensure that no additional person joins the queue after the appointed hour.

V. AFTER THE COMPLETION OF POLL

- 5.1. Close and seal the voting machine and the VVPAT, as per the instructions given in Chapter - 7.
- 5.2. Ascertain the number of female voters who have voted along with persons who have voted

without EPIC and with alternate document and who have voted with Braille and electors who have turned up to vote from the ASD list.

- 5.3. Complete Form17C (account of votes recorded and paper seal account). Furnish to every polling agent present at the close of the poll, an attested true copy of Form17C after obtaining from him a receipt for it on the declaration form referred to in Chapter - 7. Then complete the declaration in other respects.
- 5.4. Complete your Presiding Officer's Diary.
- 5.5. Seal all election papers as per instructions in Chapter - 7.
- 5.6. Follow the program of return journey to the collection centre for depositing the sealed voting machine, VVPAT and sealed packet of election papers. It is your personal responsibility to deliver the voting machine, VVPAT and other packets at the collection centre intact and obtain a receipt.

ANNEXURE – 10

(Chapter – 1, Para 1.12)

CHECK MEMO FOR PRESIDING OFFICER

ITEM	ACTION TO BE TAKEN	REMARKS
1	Obtaining and keeping in possession all relevant instructions from the Returning Officer.	Whether obtained and kept?
2	Familiarization with the other members of the polling party and maintenance of close relationship with them.	Whether done?
3	Collection of election material, List of ASD voters.	Whether ensured that all the election materials and that too in sufficient quantities and numbers have been collected?
4	Checking up of Balloting unit(s), Control Unit, VVPAT, marked copies of the electoral roll, arrow cross mark rubber stamp, green paper seals, Register of Voters, voters slips etc.	Whether done?
5	Separate entrance and exit for voters at polling stations.	Whether ensured?
6	Display of Notice specifying the polling area and the number of electors assigned and also a copy of the list of contesting candidates.	Whether done?
7	Inter-linking of Control Unit, Balloting unit(s), and VVPAT after placing Balloting unit(s) and VVPAT in Voting Compartment. Switching on Control Unit and VVPAT.	Whether done?
8	Conducting Mock poll and Result of Control Unit tallied with VVPAT paper slips. Clearing Control Unit by pressing 'CLEAR' button. Putting VVPAT paper slips in black envelope after stamping 'mock poll slip'. Prepare Mock Poll certificate.	Whether done?
9	Fixing green paper seal on result compartment of Control Unit. Allowing polling agents to note the serial number of the green paper seal.	Whether done?
10	Sealing the result section of the Control Unit by using Green Paper Seal, Address Tag and Special Tag. Sealing of VVPAT drop box using address tag.	Whether done?
11	Declaration to be made at the commencement of the poll.	Whether made?
12	Reading out the provisions of the section 128 of the R.P. Act, 1951 with regard to the secrecy of voting by Presiding Officer at the beginning of the poll.	Whether done?
13	Allowing polling agents to note the serial numbers of Balloting Unit(s), Control Unit and VVPAT.	Whether allowed?
14	Marking of indelible ink on left index finger and obtaining the signature / thumb impression on the Register of Voters (17A). Before the first voter signs in Form 17A (Register of Voters) the Polling Officer – I shall check with the Presiding Officer and record in INK in Form 17A that “Total in the Control Unit checked and found to be Zero”	Whether properly done?

15	Declaration from under-aged electors.	Whether obtained?
16	Maintenance of Presiding Officer's diary	Whether events are recorded from time to time as and when they occur?
17	Maintenance of Visit sheet.	Whether maintained?
18	Close of poll at the appointed time.	Whether done?
19	Supply of copies of account of votes recorded in Form 17C to all the polling agents.	Whether done?
20	Poll Day Report from Presiding Officers on EVM-VVPAT (Part-I to Part-V)	Whether done and obtained?
21	Declaration to be made at the close of poll.	Whether made?
22	Sealing of EVM and VVPAT and election papers.	Whether done according to instructions?

ANNEXURE - 11
(Chapter – 2, Para 2.12)

POLLING AGENTS / RELIEVING AGENTS MOVEMENT SHEET

S. No.	No. and Name of Parliamentary Constituency	No. and Name of Assembly segment	Name of Candidate	Name of Political Party	Name of Polling agents / Relieving agents	Time of Entry	Signature	Time of Exit	Signature
1.									
2.									
3.									

Signature of the Presiding Officer

ANNEXURE - 12

Specimen of Entry Pass

(To be issued by Presiding Officer on poll day)

Sl. No.
ENTRY PASS
AC No. & Name:
Polling Station No. & Name:
Name of Candidate:
Name of Polling Agent:
Name of Relief Agents, if any:
Signature of Presiding Officer

ANNEXURE - 13

Account of Entry Passes issued to Polling Agents

1. Number and Name of Assembly Constituency
2. Number and Name of Polling Station
3. Total Number of contesting candidates
4. Number of entry passes received with poll material
5. Details of entry passes issued to Poling Agents

Name of candidate	Whether entry passes issued	Signature of the Polling Agent/relief Polling Agent

6. Unused Entry Passes

Signature and seal of
Presiding Officer

ANNEXURE - 14
(Chapter – 4, Para 4.3.1)

**FORM OF DECLARATION BY ELECTOR WHOSE NAME IS IN ABSENTEE /
SHIFTED / DEAD LIST (ASD List)**

I hereby solemnly declare and affirm that I am the same person whose name appears at Serial No of Part No Of the existing electoral roll of the Constituency which was prepared / revised with respect of first date of 20..... as qualifying date. I am aware that impersonation at elections is an electoral offence under the section 171D of the Indian Penal Code.

.....
Signature/Thumb impression of the Elector

Name

Certified that the above declaration was made and subscribed by the elector above named before me.

.....
Signature of the Presiding Officer

.....
Number and name of polling station

Date

ANNEXURE - 15
(CHAPTER – 5, Para 5.8.2)

FORM OF DECLARATION BY ELECTOR ABOUT AGE

I hereby solemnly declare and affirm that my age was more than 18 years on the first date of 20..... i.e. the qualifying date with reference to which the existing electoral roll of the constituency was prepared/revised.

I am aware of the penal provisions of section 31 of the Representation of the People Act, 1950, for making any false declaration in connection with the inclusion of any name in the electoral roll or the preparation, revision or correction of the electoral roll.

Signature/ Thumb impression of the Elector.....

Father/Mother/Husband's Name.....

Part number of electoral Roll.....

Serial number of Elector

Dated.....

Certified that the above declaration was made and subscribed by the elector above named before me.

Signature of the Presiding Officer.....

Number and name of Polling station

Dated

ANNEXURE - 16
(CHAPTER – 5, Para 5.8.3)

LIST RELATED TO UNDER-AGED ELECTORS

Election to..... (name of Constituency)

No. and Name of Polling Station.....

Part I

LIST OF VOTERS FROM WHOM DECLARATION AS TO THEIR AGE HAVE BEEN OBTAINED

Sl. No.	Name of elector	Part No. and Serial No. in electoral roll	Age as entered in electoral roll	Age as assessed by the Presiding Officer
1	2	3	4	5
1.				
2.				
3.				
4.				

Part II

LIST OF ELECTORS WHO HAVE REFUSED TO MAKE DECLARATIONS AS TO THEIR AGE

S. No.	Name of Elector	Part No, and Serial No. in Electoral roll	Age as entered in Electoral roll	Age as assessed by the Presiding Officer
1	2	3	4	5
1.				
2.				
3.				

Dated:

Signature of Presiding Officer

ANNEXURE - 17
(Chapter – 5, Para 5.9.2)

DECLARATION UNDER RULE 49MA

General/Bye-Election to.....

Sl. No. and Name of Parliamentary/Assembly Constituency.....

No. and Name of Polling Station.....

**FORM OF DECLARATION BY ELECTOR TO BE FILLED BEFORE CASTING A TEST VOTE
UNDER RULE 49MA OF CONDUCT OF ELECTIONS RULES, 1961**

1. I hereby solemnly declare and affirm under sub rule (1) of Rule 49 MA of the Conduct of Elections Rules 1961 that the paper slip generated by the printer attached to the Balloting Unit has shown the name and/or symbol of a candidate other than the candidate for whom I voted by pressing the concerned blue button against the name and symbol of the candidate of my choice on the Balloting Unit. I am ready to cast a test vote again to show that the allegation made by me is true and bonafide.
2. I am aware of the penal provisions of Section 177 of the IPC that I shall be liable to be punished with imprisonment for a term which may extend to six months, or with fine which may extend to one thousand rupees, or with both, if the declaration given by me in para 1 above to the Presiding Officer appointed under Section 26 of the RP Act, 1951 is found to be incorrect.

Signature/Thumb impression of the Elector

Name of the Elector.....

Father/Mother/Husband's Name.....

Part No. of electoral roll.....

Sl. No. of elector in that Part.....

Sl. No. in Register of Voters (Form 17A)

Dated.....

Certified that the above declaration was made and subscribed by the elector above named before me.

Signature of the Presiding Officer

Dated.....

ANNEXURE - 18
(CHAPTER – 5, Para 5.2.5)

DECLARATION BY THE COMPANAION OF BLIND OR INFIRM ELECTOR

..... Assembly Constituency (comprised
within.Parliamentary Constituency)

Sl. No. and Name of Polling Station

I,son of aged..... resident of
..... hereby declare that:

- (a) I have not acted as companion of any other elector at any polling station today, the
- (b) I will keep secret the vote recorded by me on behalf of

Signature of Companion

Full address to be given

ANNEXURE - 19
(CHAPTER – 5, Para 5.7.3)

RECEIPT BOOK

<p style="text-align: center;">Annexure -VIII (Chapter- XVIII Para -5)</p> <p style="text-align: center;">RECEIPT FOR CHALLENGE FEE</p> <p>Book No.....Page No.....</p> <p>Received a sum of Rs./-2(Rupees two only) in cash from Shri.....Candidate/ Election Agent/ Polling Agent on account of deposit for challenge under rule36 of the Conduct of Election Rules, 1961.</p> <p>Date</p> <p style="text-align: right;">Presiding Officer for Polling Stations No Of Parliamentary/ Legislative Assembly Constituency</p>	<p style="text-align: center;">Annexure -VIII (Chapter- XVIII Para -5)</p> <p style="text-align: center;">Forfeited to Government</p> <p style="text-align: center;">Presiding Officer</p> <p>Received back the amount of Rs.2 (Rupees two only) under rule 36(5) of the Conduct of Election Rules, 1961.</p> <p>Date.....</p> <p>Name and Signature of Candidate/ Election Agent/Polling Agent</p>	<p style="text-align: center;">RECEIPT FOR CHALLENGE FEE</p> <p>Book No..... Page No.....</p> <p style="text-align: center;">Office of the Presiding Officer For Polling Station No.of Parliamentary/Legislative Assembly Constituency</p> <p>Received a sum ofRs.2/-(Rupees two only) in cash from ShriCandidate/ Election Agent/Polling Agent on account of deposit for challenge under rule 36 of the Conduct of Elections Rules, 1961.</p> <p>Place - Date.....</p> <p style="text-align: right;">Presiding Officer</p>
--	--	--

<p style="text-align: center;">Annexure -VIII (Chapter- XVIII Para -5)</p> <p style="text-align: center;">RECEIPT FOR CHALLENGE FEE</p> <p>Book No.....Page No.....</p> <p>Received a sum of Rs./-2(Rupees two only) in cash from Shri.....Candidate/ Election Agent/ Polling Agent on account of deposit for challenge under rule36 of the Conduct of Election Rules, 1961.</p> <p>Date</p> <p style="text-align: right;">Presiding Officer for Polling Stations No Of Parliamentary/ Legislative Assembly Constituency</p>	<p style="text-align: center;">Annexure -VIII (Chapter- XVIII Para -5)</p> <p style="text-align: center;">Forfeited to Government</p> <p style="text-align: center;">Presiding Officer</p> <p>Received back the amount of Rs.2 (Rupees two only) under rule 36(5) of the Conduct of Election Rules, 1961.</p> <p>Date.....</p> <p>Name and Signature of Candidate/ Election Agent/Polling Agent</p>	<p style="text-align: center;">RECEIPT FOR CHALLENGE FEE</p> <p>Book No..... Page No.....</p> <p style="text-align: center;">Office of the Presiding Officer For Polling Station No.of Parliamentary/Legislative Assembly Constituency</p> <p>Received a sum ofRs.2/-(Rupees two only) in cash from ShriCandidate/ Election Agent/Polling Agent on account of deposit for challenge under rule 36 of the Conduct of Elections Rules, 1961.</p> <p>Place - Date.....</p> <p style="text-align: right;">Presiding Officer</p>
--	--	--

ANNEXURE - 20
(CHAPTER – 5, Para 5.7.4)

LETTER OF COMPLAINT TO THE S.H.O. POLICE

To
The Station House Officer,
.....

**Subject: Election to.....Assembly Constituency comprised within.....
..... Parliamentary Constituency. Impersonation at Polling Station
.....(number and name).**

Date of poll

Sir,

I am to report that Shri..... son of Shri....., and resident of
has challenged the identity of the person who is being handed over to..... This person
claimed to be..... whose name appears at Serial No..... in Part No.....of the
electoral roll of..... constituency. He could not prove himself to be this elector. In my opinion he is an
imposter. I am to request you to take necessary action as required under section 171-F of the Indian Penal
Code.

Yours faithfully,
Signature,
Presiding Officer

Place.....

Date.....

Copy forwarded to:

The Returning Officer for Assembly Constituency
The Returning Officer forParliamentary Constituency
Signature, Presiding Officer

RECEIPT

The above letter and the person referred to therein were handed over to me at.....(hour) on.....
(date) by the Presiding Officer.

Here insert ex-officio designation of the concerned Returning Officer

Signature

ANNEXURE - 21

(Chapter – 1, Para 1.8.XIII)

HANDLING OF CU BU-VVPAT FAILURES/ERRORS DURING POLL PREPARATION OF POLLING OFFICIALS FOR FAULT HANDLING SUGGESTIONS

Certain contingencies may arise during the polling process which may require certain actions. These are as follows: -

- a. In case the CU or the BU does not work properly: (i) Switch off the CU and don't switch it on again (ii) Replace the complete set of EVM and VVPAT by another set of BUs, CU and VVPAT (iii) However, in such case only one vote to each contesting candidate including NOTA should be polled in the mock poll. (iv) Continue the poll with the new EVM set, after clearing mock poll data and removing printed paper slips from VVPAT Drop Box of the new VVPAT.
- b. In case Display Panel of the CU displays "Link Error": (i) Check that the cable connections are proper by visual inspection (don't remove and reconnect the connectors); (ii) If "Link Error" still persists, replace the complete set of EVM and VVPAT.
- c. In case the Display Panel of the CU displays "**CHANGE VVPAT BATTERY**": Switch off the CU and replace the Power Pack of VVPAT. It should be ensured that in no case replacement of power pack is done without switching off the CU. No need of Mock Poll in this case.
- d. In case the Display Panel of the CU displays VVPAT Error 2.1 – 2.14 and the Presiding Officer has not pressed the BU enable button: Switch off the CU and replace the defective VVPAT unit with the new VVPAT unit. It shall be ensured that in no case replacement of VVPAT unit is done without switching off the Control Unit. No need of Mock Poll in this case.
- e. In case the printed paper slip has not been cut and is hanging from the paper roll: Replace the VVPAT, but no effort should be made to make it fall into the drop box. It should be allowed to remain hanging, as it is not to be counted at the time of counting of the ballot slips. The details of such an occurrence should be clearly recorded in the Presiding Officers diary in the following format:
 - i. The date and time of the occurrence.
 - ii. The name of the voter and his serial number in part in the electoral roll who was allowed to cast his vote after replacement of VVPAT.
 - iii. Whether the voter cast his vote after replacement of VVPAT or went away without casting his vote.
 - iv. The Total number of votes cast before the occurrence.
- f. In case a voter alleges after recording his vote that the printed paper slip generated by the printer has shown the name or symbol of a candidate other than the one he voted for: Action should be taken as per provisions of Rule 49MA of the Conduct of Elections (Amendment) Rules, 2013:
 - (i) Obtain a declaration from the complainant in the Declaration Form under his/her signature/thumb impression;
 - (ii) Proceed to the Voting Compartment along with the complainant and polling agents present in the polling station at that moment;
 - (iii) The voter shall be asked to cast a test vote in favour of any candidate and make second entry related to that elector in the Form-17A;
 - (iv) Observe carefully whether the Printer has printed the paper slip correctly;
 - (v) If the complaint of the elector is found genuine, the Presiding Officer shall report the facts immediately to the RO and stop further polling at the station;
 - (vi) If the complaint of the elector is found false, make a remark to that effect against the second entry relating to that elector in Form-17A mentioning the serial number and name of the candidate for whom such test vote has been recorded and obtain the signature or thumb impression against such remark. Further make necessary entries regarding such test vote in item 5 in Part-I of Form 17-C.

ANNEXURE – 22

(Chapter –7, Para 7.6)

FORM M21-RECEIPT OF RETURN OF ELECTION RECORDS AND MATERIAL AFTER POLL

(TO BE PREPARED IN DUPLICATE)

Statement showing particulars of used Electronic Voting Machine(s) and sealed covers and other articles hand over by the Presiding Officer of Polling Station No..... of Assembly constituency comprised in the Parliamentary Constituency.

A. Electronic Voting Machine(s):

- (i) The sealed Electronic Voting Machine(s):
 - a. Number of sealed CU: Nos
 - b. Number of sealed BU: Nos
 - c. Number of sealed VVPAT: Nos
- (ii) The unused Electronic Voting Machine(s)
 - a. Number of unused CU: Nos
 - b. Number of unused BU: Nos
 - c. Number of unused VVPAT: Nos

B. Packets:

(I) First packet: EVM Papers

- (i) Unsealed envelope containing the account of votes recorded (Form-17C),
- (ii) Unsealed envelope containing the Presiding Officer Report I (Mock-Poll Certificate), II & III
- (iii) Printed VVPAT paper slips of Mock Poll should be kept in Black Coloured Sealed Envelope

In case of simultaneous election, separate first packet of EVM Papers in pink colour for polled EVM for assembly poll.

(II) Second packet: Scrutiny Cover

- (i) Unsealed envelope containing the Presiding Officer's Diary
- (ii) Sealed envelope containing the register of voters (17A)
- (iii) Unsealed envelope containing Visit Sheet
- (iv) Unsealed envelope containing the list of blind and infirm electors in Form 14-A and the declarations of the companions

(III) Third packet: Statutory Cover

- (i) Sealed envelope containing the marked copy of the electoral roll and list of CSVs, if any;
- (ii) Sealed envelope containing voter's slips;
- (iii) Sealed envelope containing unused tendered ballot papers;
- (iv) Sealed envelope containing the used tendered ballot papers and the list in Form 17-B;
- (v) Sealed envelope containing the list of challenged votes in Form 14;

In case of simultaneous election, pink envelope containing the pink voter's slip for assembly poll should be kept in this third packet.

(IV) Fourth packet: Non-Statutory Cover

- (i) Unsealed envelope containing the copy or copies of electoral roll (other than the marked copy);
- (ii) Unsealed envelope containing the appointment letters of Polling Agents in Form 10 and

- accounts of appointment of polling agent;
- (iii) Unsealed envelope containing the election duty certificate in Form 12-B
- (iv) Unsealed envelope containing the declarations by the presiding officer
- (v) Unsealed envelope containing the receipt book and cash, if any, in respect of challenged votes;
- (vi) Unsealed envelope containing (i) unused and damaged paper seals and (ii) unused and damaged special tags;
- (vii) Unsealed envelope of unused voter's slip
- (viii) for the declarations obtained from electors as to their age and the list of electors who have refused to make declarations as to their age
- (ix) Form of declaration by elector under Rule 49MA (Test Vote);
- (x) Form of declaration by elector whose name is in ASD list;
- (xi) Letter of complaint to the S.H.O. Police;

In case of simultaneous election, pink envelope containing the declaration by the presiding officer should be kept in this fourth pocket.

- (V) Fifth packet: Handbook. Instructions and other
 - (i) Hand Book for Presiding Officer;
 - (ii) Instructions of Electronic Voting Machine & VVPAT, a) Posters on How to cast vote on EVM and VVPAT, b) Brochure for Presiding Officer on use of EVM and VVPAT and c) Trouble shooting on use of EVM and VVPAT;
 - (iii) Sealed envelope containing, a) Indelible ink set with stopper having been secured on each phial effectively with molten candle or wax applied thereon to prevent leakage or evaporation and b) used self-inking pads)
- (VI) Sixth Packet: Other Materials
 - (i) List of contesting candidates Form 7A
 - (ii) Photocopy of signature of candidates
 - (iii) Other unused forms.
 - (iv) Metal seal of the Presiding Officer;
 - (v) Arrow cross-mark rubber stamp for marking tendered ballot papers;
 - (vi) Cup for setting the indelible ink
- (VII) Two stationery containers containing used and remaining stationery items

- C. Voting Compartments : Nos
- D. Acquittance Roll of T.A to Polling Personnel if any : Nos.

Handed Over

Taken charge

Signature of Presiding Officer
Polling Station No.....

Name & Signature of the receiving Officer

ANNEXURE - 23
(Chapter - 2, Para 2.3.VI)

Voting Compartment – Dimensions & Cascading of Balloting Units
ON THREE SIDE - FACING THE WEB CAMERA



Name of State/UT:

AC/PC Name:

AC/PC Number:

Date of Poll:

Polling Station Name:



Name of State/UT:

AC/PC Name:

AC/PC Number:

Date of Poll:

Polling Station Name:

ON REMAINING TWO SIDES OF THE VOTING COMPARTMENT



भारत निर्वाचन आयोग

मतदान कम्पार्टमेंट

ELECTION COMMISSION OF INDIA

VOTING COMPARTMENT

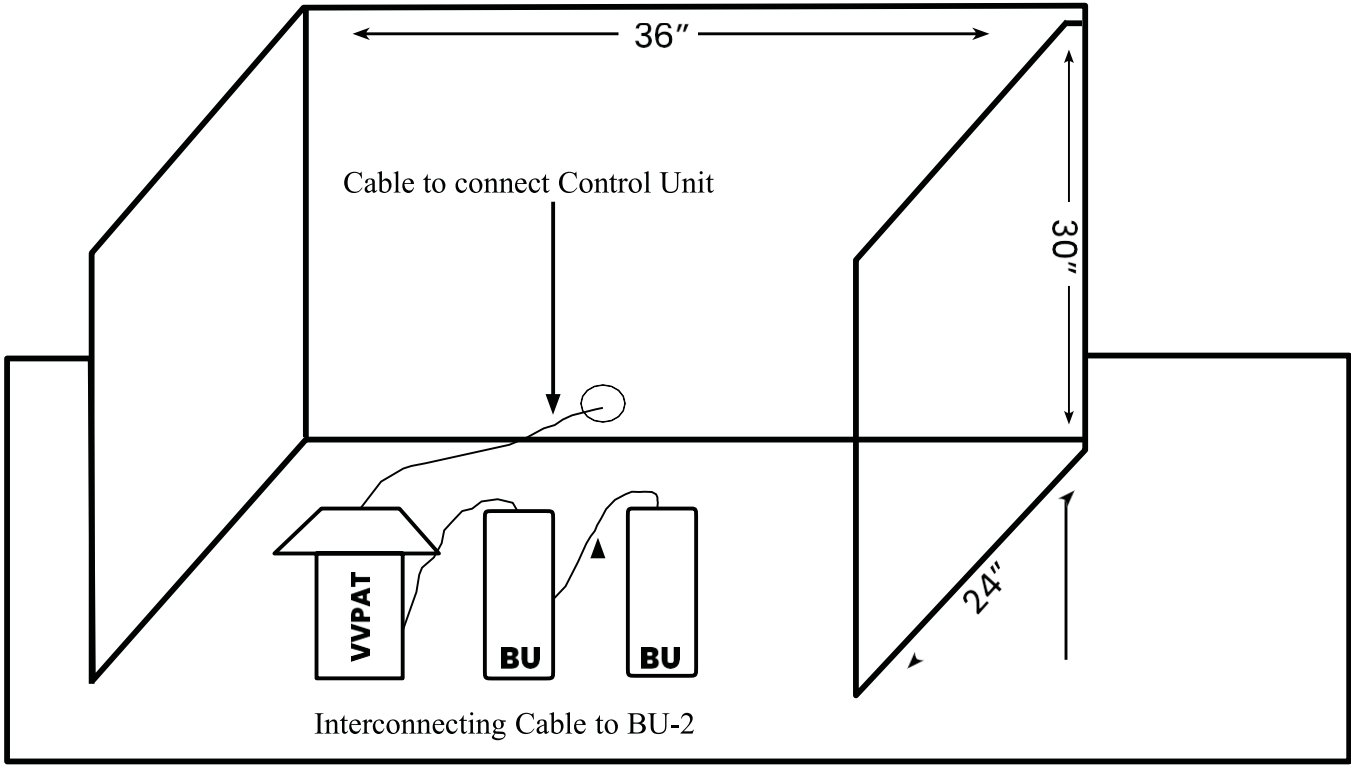
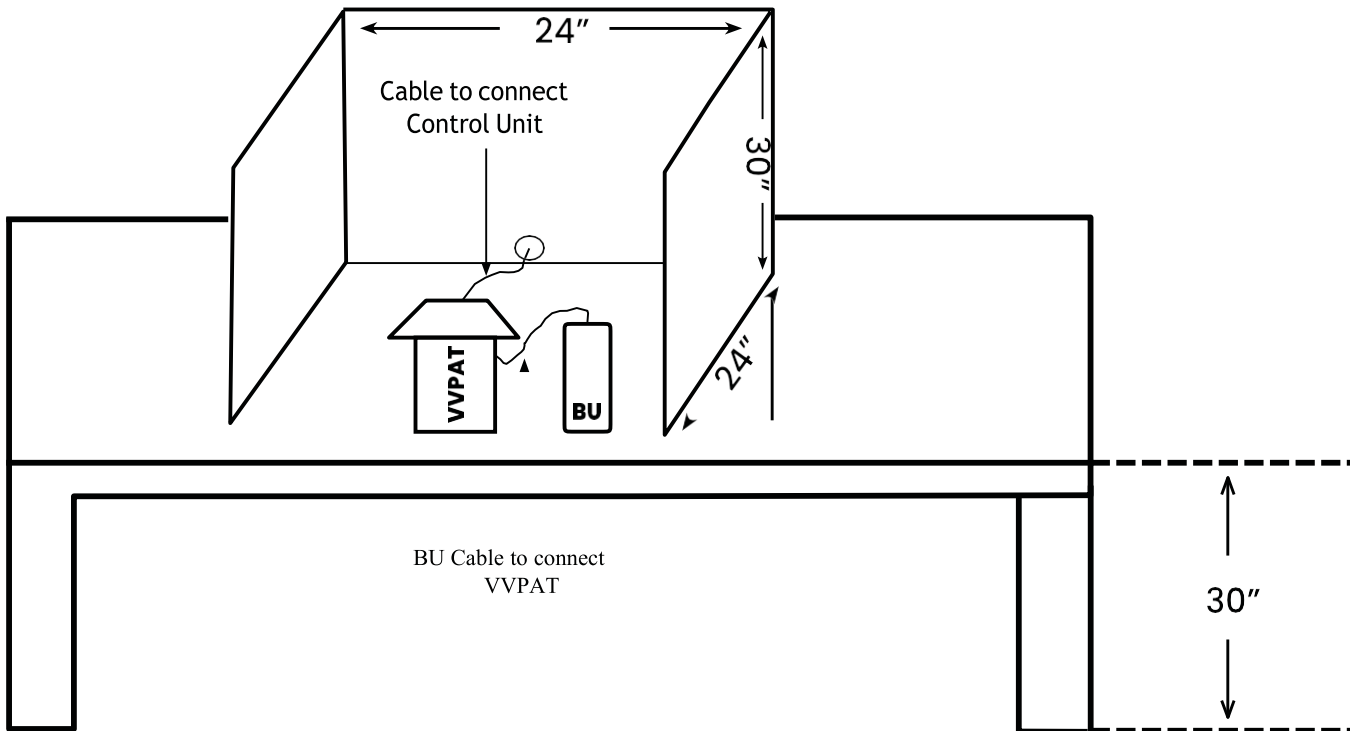

CASCADING OF TWO BALLOT UNITS

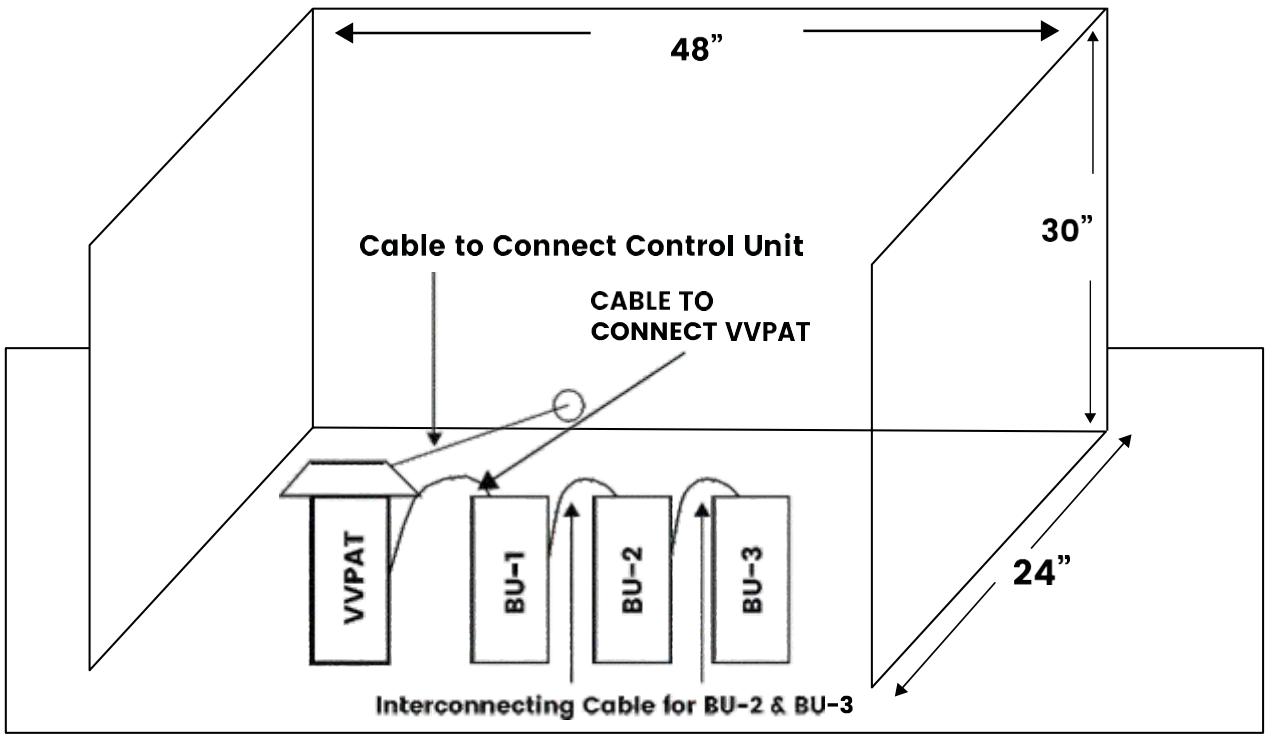

CASCADING OF THREE BALLOT UNITS

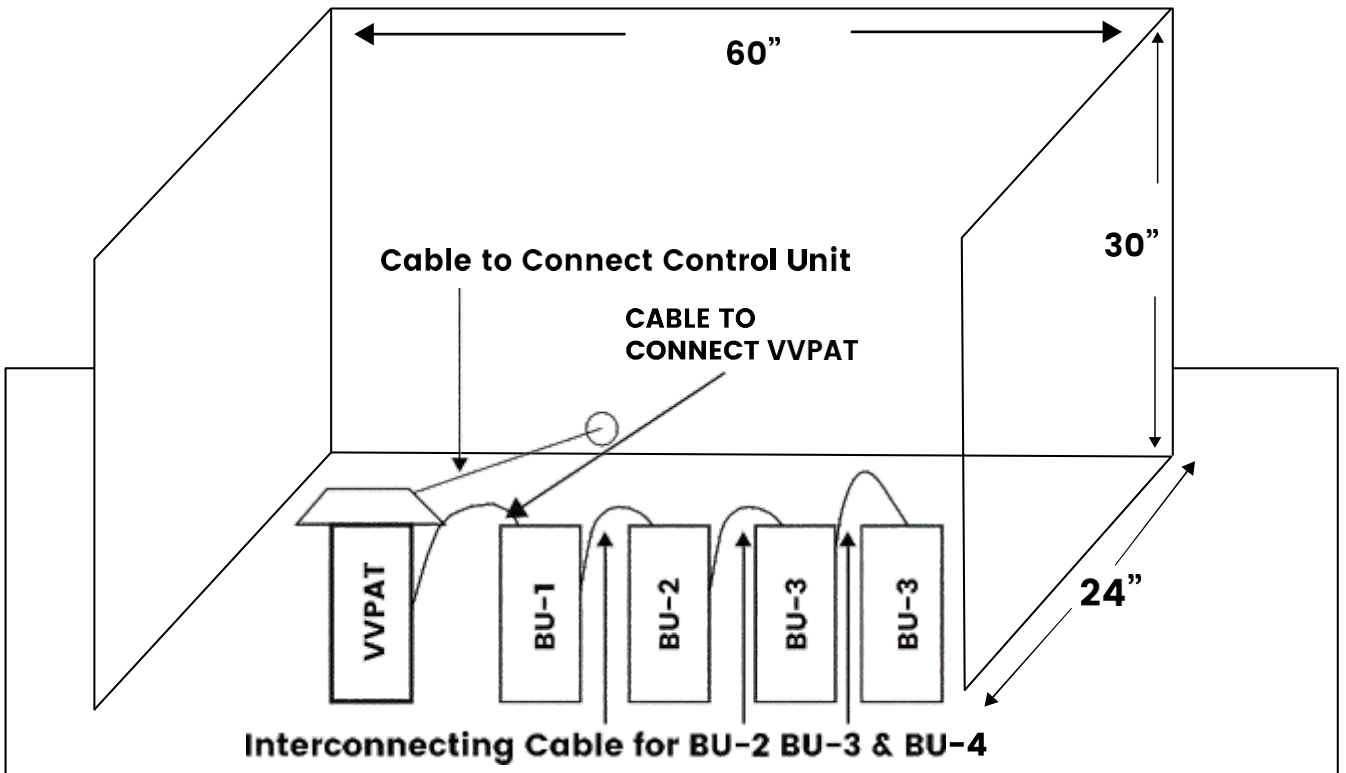

CASCADING OF FOUR BALLOT UNITS



भारत निर्वाचन आयोग
Election Commission of India

Nirvachan Sadan, Ashoka Road, New Delhi-110001